

Project Scope: Mixed- Use Development

PLANNING DEPARTMENT SUBMITTAL _____

BUILDING DEPARTMENT SUBMITTAL _____

SCOPE OF WORK:

- COMPLETE DEMOLITION OF EXISTING STRUCTURES
- 1-STORY MIXED-USE, 3,170 SF
 - DUPLEX DWELLING UNIT AND RESTAURANT

NEW CONSTRUCTION MIXED-USE DEVELOPMENT

- 4-STORY MIXED USE: 9,884 SF
- PODIUM PARKING: 10 SPACES
- RETAIL ON GROUND FLOOR: 848 SF
- APARTMENTS: 7 UNITS
- AMENITIES: LOBBY, LOUNGE, GYM, STUDY ROOM

Project Data

PROJECT LOCATION: 396 THIRD AVE, REDWOOD CITY, CA 94063

APN: 060-083-360

ZONING: NMU NEIGHBORHOOD MIXED-USE

GENERAL PLAN: COMMERCIAL NEIGHBORHOOD

EXISTING USE: RESTAURANT

PROPOSED USE: MIXED-USE

LOT SIZE: 6,598.31 SF/0.15 ACRES

MIN. SET BACKS:

HEIGHT LIMIT: 40'-0"
 MAX HEIGHT FOR EQUIPMENT: 45'-0"
 MIN LEVELS: 2

ADJACENT TO R-1

FRONT: 0'-0"
 SIDE (ABUTTING R-1): 5'-0"
 SIDE (NOT ABUTTING R-1): 0'-0"
 REAR: 20'-0"

MAX BUILDING HEIGHT: 40'-0"

MAX RESIDENTIAL DENSITY: 60 DU / NET ACRE

MAX BUILDING COVERAGE: 80% X 6,598.31 SF = 5,278.64 SF

(P) BUILDING COVERAGE: 4,384 SF < 5,278.64 SF = OKAY

MAX BUILDING FLOOR AREA

MIXED-USE DEVELOPMENT:
 (P) F.A.R.: 150% X 6,598.31 SF = 9,897.46 SF
 9,884 SF (HABITABLE) < 9,897.46 SF = OKAY
 SEE SHEET A003 FOR F.A.R. ANALYSIS

BUILDING SIZES (HABITABLE):

LEVEL 1: 1,452 SF
 LEVEL 2: 3,060 SF
 LEVEL 3: 2,684 SF
 LEVEL 4: 2,688 SF
 TOTAL: 9,884 SF

MAX # OF SIGNS:

1 PER PARCEL, OR 1 PER 200' PARCEL STREET FRONTAGE, OR 1 SIGN PER USE WHICHEVER IS GREATEST

MAX SIGN DISPLAY AREA: 3/4 SF PER FOOT PARCEL STREET FRONTAGE

MAX WINDOW SIGN AREA: NOT TO EXCEED 25% OF THE WINDOW AREA

MAX SIGN HEIGHT: ATTACHED: NOT TO EXCEED HEIGHT OF BLDG/STRUCTURE / ROOF

FREESTANDING: NOT TO EXCEED 15'-0"

BUILDING INFORMATION:

OCCUPANCY/ CONSTRUCTION TYPE/ SPRINKLER SYSTEM:

- A (ASSEMBLY) II-B / SPRINKLERED
- M (MERCANTILE) II-B / SPRINKLERED
- S-1 (LOW HAZARD STORAGE) II-B / SPRINKLERED
- S-2 (LOW HAZARD STORAGE) II-B / SPRINKLERED
- R-2 (RESIDENTIAL) V-B / SPRINKLERED

AUTOMATIC FIRE SPRINKLERS SYSTEM-PER CBC SECTION 903.2.8 AND 903.2.10:

- AN AUTOMATIC SPRINKLER SYSTEM INSTALLED IN ACCORDANCE WITH SECTION 903.3 SHALL BE PROVIDED THROUGHOUT ALL BUILDINGS WITH A GROUP R FIRE AREA.
- AN AUTOMATIC SPRINKLER SYSTEM SHALL BE PROVIDED IN BUILDING CLASSIFIED AS GROUP S-2 ENCLOSED PARKING GARAGES IN ACCORDANCE WITH SECTION 406.4, WHERE THE ENCLOSED PARKING GARAGE IS LOCATED BENEATH OTHER GROUPS.

ALLOWABLE BUILDABLE HEIGHT, STORIES, AND AREA PER CBC TABLES 504.3, 504.4, 506.2

LEVEL	OCCUPANCY	SPRINKLERS (Y/N)	CONST. TYPE	HEIGHT		STORIES		AREA SF
				(ALLOWED, PROPOSED)	(ALLOWED, PROPOSED)	(ALLOWED, PROPOSED)	(ALLOWED, PROPOSED)	
1	A-3	Y	II-B	75 FT, 10.5 FT	3, 1	9,500 SF, 204 SF		
1	M	Y	II-B	75 FT, 10.5 FT	3, 1	37,500 SF, 922 SF		
1	S-1	Y	II-B	75 FT, 10.5 FT	3, 1	52,500 SF, 283 SF		
1	S-2	Y	II-B	75 FT, 10.5 FT	3, 1	78,000 SF, 4,459 SF		
2	R-2	Y	V-B	75 FT, 40.5 FT	3, 3	4,800 SF, 2,605 SF		
3	R-2	Y	V-B	75 FT, 40.5 FT	3, 3	4,800 SF, 2,254 SF		
4	R-2	Y	V-B	75 FT, 40.5 FT	3, 3	4,800 SF, 2,261 SF		

APPROVED WITH CONDITIONS



REVIEWED

By William Saxton at 6:31 am, May 05, 2020

MIXED - USE DEVELOPMENT

REDWOOD CITY

CALIFORNIA



① Street View Rendering
 1 1/2" = 1'-0"

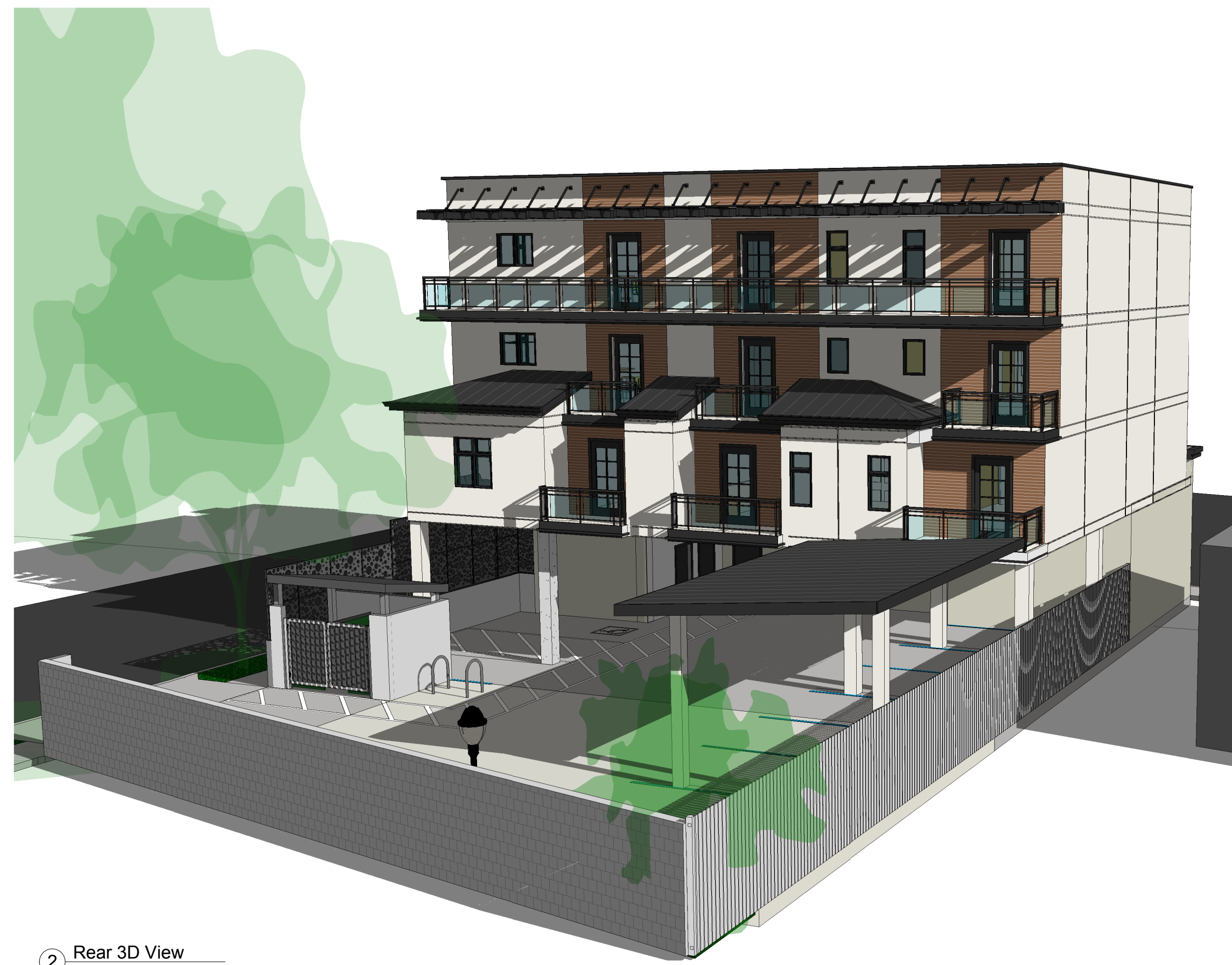

② Rear 3D View

Public Work Notes & Site Plan Notes

1. CONTRACTOR IS RESPONSIBLE FOR DUST CONTROL AND INSURING AREA ADJACENT TO WORK IS LEFT IN A CLEAN CONDITION.
2. UTILIZE BEST MANAGEMENT PRACTICES (BMP'S), AS REQUIRED BY THE STATE WATER RESOURCES BOARD, FOR ANY ACTIVITY, WHICH DISTURBS SOIL.
3. CONTRACTOR IS RESPONSIBLE FOR ALL TEST, INSPECTIONS AND PROCEDURAL REQUIREMENTS PER SAN MATEO COUNTY.
4. OPERABLE SMOKE DETECTORS MUST BE IN PLACE PRIOR TO RE-OCCUPY DWELLINGS.
5. PLUMBING & ELECTRICAL SURVEY REQUIRED FOR METER RELEASE.
6. ADDITIONS, ALTERATIONS OR REPAIRS SHALL CONFORM TO ANY BUILDING OR STRUCTURE WITHOUT REQUIRING THE EXISTING BUILDING OR STRUCTURE TO COMPLY WITH ALL THE REQUIREMENTS OF THE CBC, PROVIDED THE ADDITION ALTERATION OR REPAIR CONFORMS TO THAT REQUIRED FOR NEW BUILDING OR STRUCTURE PER CBC 2016.
7. CONTRACTOR TO VERIFY SIZE & LOCATION OF ALL UTILITY CONNECTIONS. CONTRACTOR TO PROVIDE ALL NEW UTILITY CONNECTIONS AND/OR UPGRADE EXISTING AS REQUIRED. CONTRACTOR SHALL OBTAIN ALL NECESSARY PERMITS AND APPROVALS AS REQUIRED BY GOVERNING AGENCIES.
8. CONTRACTOR SHALL OBTAIN ALL NECESSARY DEMOLITION PERMITS AND APPROVALS INCLUDING ASBESTOS ABATEMENT AS PART OF THE BASE BID.
9. PER CBCSC 301.1.1 - RESIDENTIAL BUILDINGS UNDERGOING PERMITTED ALTERATIONS, ADDITIONS OR IMPROVEMENTS SHALL REPLACE NONCOMPLIANT PLUMBING FIXTURES WITH WATER-CONSERVING PLUMBING FIXTURES. PLUMBING FIXTURES REPLACEMENT IS REQUIRED PRIOR TO ISSUANCE OF A CERTIFICATE OF FINAL COMPLETION, CERTIFICATE OF OCCUPANCY OR FINAL PERMIT APPROVAL BY THE LOCAL BUILDING DEPARTMENT.
10. PER CBCSC 301.1.1 - WHERE ADDITION OR ALTERATION INCREASED THE BUILDING'S CONDITIONED AREA, VOLUME, OR SIZE, THE REQUIREMENTS OF CALGreen CHAPTER 4 SHALL APPLY ONLY TO AND WITHIN THE SPECIFIC AREA OF THE ADDITION OR ALTERATION.

Sheet Index

Sheet Number	Sheet Name
A000	Cover Sheet & Building Information
A001	Architectural Notes
1	Boundary & Topographic Map
C1	Title Sheet
C2	Demolition Plan
C3	Grading & Drainage Plan
C4	Building Cross Section
C5	Erosion Control Plan & Construction Operation Plan
C6	Blueprint for a Clean Bay
C7	County Standard Details
A002	Proposed Parking Analysis
A003	Floor Plan Analysis
A004	Occupancy & Egress Analysis, Level 1
A005	Occupancy & Egress Analysis, Levels 2- 4
A006	Fire Apparatus Access Analysis
A100	Site Plan, Existing & Proposed
A101	Level 1 & 2 Plans, Proposed
A102	Level 3 & 4 Plans, Proposed
A103	Roof Plan, Proposed
A200	Elevations Material
A201	Elevations B&W
A300	Proposed Cross Section
A400	Material Board

Applicable Code

1. 2019 CALIFORNIA BUILDING CODES PART 1, 6, 10 & 11
2. 2019 CALIFORNIA BUILDING CODES PART 2, 2.5, 3-5, 8-9, 12
3. 2019 CALIFORNIA RESIDENTIAL CODE PART 2.5
4. 2019 CALIFORNIA MECHANICAL CODE
5. 2019 CALIFORNIA PLUMBING CODE
6. 2019 CALIFORNIA ENERGY CODE
7. 2019 CALIFORNIA FIRE CODE
8. 2019 CALIFORNIA GREEN BUILDING CODES
9. ALL OTHER STATE AND LOCAL LAWS, ORDINANCES AND REGULATIONS
10. SAN MATEO COUNTY MUNICIPAL CODE

Vicinity Map

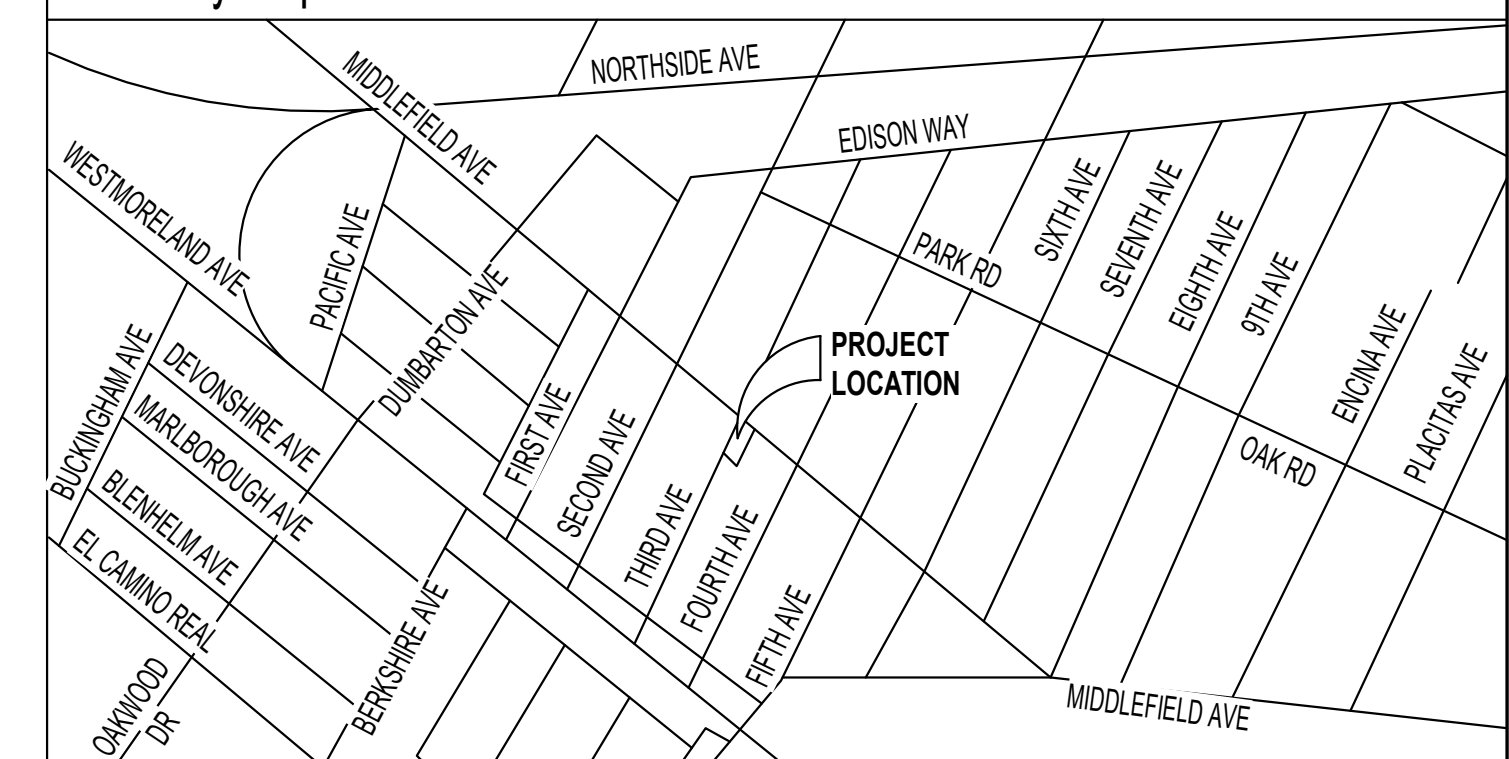

Cover Sheet & Building Information



WERRAN JIA, JENNY C WONG & DANNA BAHAMONDA, DESIGNER
 GKW ARCHITECTS, INC.
 710 MCCLAIN LANE, SUITE 108, CAMPBELL, CA 95008
 (408) 783-1481 | WWW.GKWARCHITECTS.COM



396 Third Ave
 Mixed-Use Development
 396 Third Ave., Redwood City, CA 94063

Rev. #	Date	Description
1	2019.10.31	Planning, Geo., PW
2	2019.10.31	Fire
3	2020.02.05	Fire

Cover Sheet & Building Information
 A000
 SCALE 1 1/2" = 1'-0"
 2/6/2020 9:57:16 AM

Project Directory

OWNER
JENNY NGUYEN, OWNER
3619 WESTVIEW DRIVE, SAN JOSE, CA 95148
650-716-6496 | JENNYHA5000@YAHOO.COM

ARCHITECT
GKW ARCHITECTS, INC.
GORDON K WONG, AIA, LEED GA, CSLB
710E MCCLINCY LANE SUITE 109, CAMPBELL, CA 95008
408-796-1845 | GORDONKWONG@GKWARCHITECTS.COM

LAND SURVEYOR / CIVIL ENGINEER
LC ENGINEERING
NINH M. LE
598 E SANTA CLARA ST, #270
SAN JOSE, CA 95112
408-806-7187
NLE@LCENGINEERING.NET

Agency Directory

SAN MATEO COUNTY, PLANNING & BUILDING DIVISION
455 COUNTY CENTER, 2ND FLOOR
REDWOOD CITY, CA 94063

MAIN: 650-363-4161
PLANNING: 650-363-1825
BUILDING INSPECTION: 650-599-7311
CODE COMPLIANCE: 650-363-4825

HOURS: M-F 7:30AM - 5:00PM
PLNGBLDG@SMCGOV.ORG

Abbreviations

A	ABV ABOVE AC ASPHALT CONCRETE AD AREA DRAIN ADDL ADDITIONAL AFF ABOVE FINISH FLOOR ASPH ASPHALT	G	GALV GALVANIZED GC GENERAL CONTRACTOR GL GLASS GND GROUND GWB GYPSUM WALL BOARD GYP GYPSUM	N	(N) NEW N NORTH NIC NOT IN CONTRACT NOM NOMINAL NP NO PARKING NR NON-RATED NTS NOT TO SCALE	S	SCD SEE CIVIL DRAWINGS SCHD SCHEDULE SD STORM DRAIN SECT SECTION SED SEE ELECTRICAL DRAWINGS SF SQUARE FOOT OR FEET SHR SHOWER SHT SHEET SHTG SHEATHING SIM SIMILAR SJ SEISMIC JOINT SL SEALANT SLD SEE LANDSCAPE DRAWINGS SM SHEET METAL SMD SEE MECHANICAL DRAWINGS SOF SOFFIT SOG SLAB ON GRADE SPD SEE PLUMBING DRAWINGS SPEC/S SPECIFICATION SQ SQUARE SS SANITARY SEWER SSD SEE STRUCTURAL DRAWINGS STC SOUND TRANSMISSION COEFFICIENT STD STANDARD STL STEEL STOR STORAGE STRL STRUCTURAL SY SQUARE YARD
B	BITUM BITUMINOUS BKG BACKING BLDG BUILDING BM BEAM BR BACKER ROD BUR BUILT-UP-ROOF BDR BEDROOM BW BOTTOM OF WALL	H	HDBD HARDBOARD HDR HEADER HDWR HARDWARE HDWD HARDWOOD HTR HEATER HVAC HEATING, VENT. & A.C.	O	OA OVERALL OC ON CENTER OD OUTSIDE DIAMETER/ DIMENSION OFCI OWNER FURNISHED CONTRACTOR INSTALLED OFOI OWNER FURNISHED OWNER INSTALL UON UNLESS OTHERWISE NOTES		
C	CAB CABINET CB CATCH BASIN CEM CEMENT CF CUBIC FEET CJ CONTROL JOINT CL CLOSET CTL CENTERLINE CLG CEILING CONC CONCRETE CPT CARPET	I	IN INCH INCAND INCANDESCENT INSUL INSULATION INT INTERIOR INV INVERT	P	PEN PENETRATION PERF PERFORATED PERP PERPENDICULAR PL PLATE PLAS PROPERTY LINE PLAS PLASTER PLBG PLUMBING PLWD PLYWOOD PNL PANEL POC POINT OF CONNECTION PP PERMEABLE PAVERS PREFAB PREFABRICATED PSF POUNDS PER SQUARE FOOT PSI POUNDS PER SQUARE INCH PTD PAINTED PTR PRESSURE TREATED PTRWDQ PRESSURE TREATED WOOD	T	T&B TOP AND BOTTOM T&G TONGUE AND GROOVE TC TOP OF CURB TOC TOP OF CONCRETE TOP TOP OF PAVING TOS TOP OF STEEL TRD TREAD TW TOP OF WALL
D	DECK DR DRAIN	K	K KIPS KIT KITCHEN KP KICK PLATE	QTY	QTY QUANTITY		
E	(E) EXISTING E EAST ELEC ELECTRICAL EP ELECTRICAL PANEL EXT EXTERIOR	L	LOC LOCATION LT LIGHT	R	R REVEAL OR RISER RAD RADIUS RCP REINFORCED CONCRETE PIPE RD ROOF DRAIN REF REFERENCE REFL REFLECTED REFR REFRIGERATOR RET RETAINING OR RETARDANT REG REGISTER RO ROUGH OPENING	U	UL UNDERWRITERS LABORATORIES UTIL UTILITIES
F	FDN FOUNDATION FH FIRE HYDRANT FIN FINISH FF FINISH FLOOR FL FLOW LINE FLUOR FLUORESCENT FOC FACE OF CONCRETE FOF FACE OF FINISH FOS FACE OF STUD FR FIRE RATED FS FLOOR SINK FSL FIRE SPRINKLER FTG FOOTING FURR FURRING	M	MB MACHINE BOLT MDF MEDIUM DENSITY FIBERBOARD MECH MECHANICAL MEMB MEMBRANE MET METAL MH MANHOLE MSC MISCELLANEOUS MTD MOUNTED MTL METAL			V	V VITREOUS CLAY PIPE VERT VERTICAL VTR VENT THROUGH ROOF
						W	W WEST OR WIDTH WC WATER CLOSET WD WOOD WDW WINDOW WO WITHOUT WP WATER PROOF WPT WORKING POINT WR WATER RESISTANT

General Notes

- IT IS THE RESPONSIBILITY OF THE CONTRACTOR AND SUBCONTRACTORS TO CHECK AND VERIFY ALL DIMENSIONS AND CONDITIONS INDICATED ON THESE DRAWINGS AND MAKE KNOWN ANY DISCREPANCIES PRIOR TO COMMENCING THEIR WORK. ALL WORK SHALL BE PERFORMED IN ACCORDANCE WITH ALL APPLICABLE REGULATIONS INCLUDING BUT NOT LIMITED TO NATIONAL, CITY, STATE, LOCAL CODES AND ORDINANCES WHICH MAY BE IN EFFECT. ALL MATERIALS, INSTALLATION PROCEDURES AND PLANS SHALL BE APPROVED BY ALL APPLICABLE CODE ENFORCEMENT AUTHORITIES HAVING JURISDICTION, AND IT SHALL BE THE CONTRACTOR'S RESPONSIBILITY TO OBTAIN AND PAY FOR ALL NECESSARY PERMITS AND APPROVALS FOR THE WORK.
- THESE DRAWINGS ARE INTENDED FOR USE IN A NEGOTIATED CONSTRUCTION CONTRACT AND THEREFORE, MAY NOT SPECIFICALLY DETAIL OR SPECIFY MATERIAL AND / OR MANUFACTURERS. THE CONTRACTOR SHALL PROVIDE ALL SAMPLES AND OR CUTS AS REQUIRED TO ASSIST OWNER OR HIS AGENT IN MAKING MATERIAL SELECTIONS. FOR THE PURPOSE OF ESTIMATING, THE CONTRACTORS SHALL USE THE MATERIALS SELECTED BY THE OWNER, OR IN ABSENCE OF SAME, SHALL PROVIDE AN ALLOWANCE AMOUNT AND SO CONDITION ANY COST ESTIMATE. ALL MATERIALS SPECIFIED IN THESE DRAWINGS SHALL BE INCLUDED IN SUCH ESTIMATE.
- NO GUARANTEE OF QUALITY OF CONSTRUCTION IS IMPLIED OR INTENDED BY THE ARCHITECTURAL DOCUMENTS, AND THE CONTRACTOR SHALL ASSUME FULL RESPONSIBILITY FOR ANY OR ALL CONSTRUCTION DEFICIENCIES.
- THE GENERAL CONTRACTOR SHALL HOLD HARMLESS, INDEMNIFY AND DEFEND THE ARCHITECT FROM ANY ACTION INITIATED BY THE OWNER OR ANY SUBSEQUENT OWNERS FOR CONSTRUCTION DEFICIENCIES, MODIFICATIONS OR SUCH CONDITIONS WHICH MAY BE BEYOND THE CONTROL OF THE ARCHITECT.
- ALL WORK SHALL COMPLY WITH AND RECORD THE CONDITIONS OF ALL EXISTING SITE IMPROVEMENTS INCLUDING PAVED AREAS. THE GENERAL CONTRACTOR SHALL MAKE KNOWN ALL EXISTING DAMAGED OR DISREPAIR ITEMS AND CONDITIONS THAT MAY WORSEN DUE TO THE CONSTRUCTION. ALL ITEMS IN GOOD CONDITION SHALL BE MAINTAIN IN THEIR PRESENT CONDITION AND ANY REPAIR OR DAMAGE WHICH OCCURS DURING CONSTRUCTION SHALL BE THE RESPONSIBILITY OF THE CONTRACTOR.
- CONTRACTOR SHALL THOROUGHLY EXAMINE THE SITE AND SATISFY HIM OR HERSELF AS OF THE CONDITIONS UNDER WHICH THE WORK IS TO BE PERFORMED. THE CONTRACTOR SHALL VERIFY AT THE SITE ALL MEASUREMENTS AFFECTING HIS OR HER WORK AND SHALL BE RESPONSIBLE FOR THE CORRECTNESS OF SAME. NO EXTRA COMPENSATION WILL BE ALLOWED TO THE CONTRACTOR FOR THE EXPENSES DUE TO HIS OR HER NEGLIGENCE TO EXAMINE OR FAILURE TO DISCOVER CONDITIONS WHICH MAY AFFECT HIS OR HER WORK.
- ALL WORK SHALL BE COORDINATED WITH THE STRUCTURAL, MECHANICAL, ELECTRICAL, PLUMBING, ARCHITECTURAL, FIRE PROTECTION AND LIGHTING DRAWINGS APPLYING TO THIS PROJECT PRIOR TO SUBMITTING SHOP DRAWINGS FOR FABRICATION APPROVAL.
- IT IS THE RESPONSIBILITY OF THE CONTRACTOR TO COORDINATE WITH ALL INVOLVED PARTIES AND PREPARE SHOP DRAWINGS.
- ALL NEW INTERIOR PAINT COLOR, FLOOR, WALLS AND CEILING FINISHES SHALL BE SELECTED BY OWNER AT THE TIME WHEN IT IS NECESSARY FOR THE COMPLETION OF THE PROJECT.
- THE CONTRACTOR SHALL PERFORM ALL CUTTING AND PATCHING REQUIRED TO COMPLETE THE WORK OR TO MAKE ITS PARTS FIT TOGETHER PROPERLY WITHOUT COMPROMISING THE QUALITY OF THE WORK.
- THE CONTRACTOR SHALL BE RESPONSIBLE FOR ADEQUATE BRACING, SHORING, AND PROTECTING ALL WORK DURING CONSTRUCTION, AGAINST DAMAGE, BREAKAGE, COLLAPSE, DISTORTIONS, AND OFF ALIGNMENTS ACCORDING TO CODES AND STANDARDS OF GOOD PRACTICE.
- ALL PUBLIC IMPROVEMENTS SHALL BE MADE IN ACCORDANCE WITH THE LATEST ADOPTED CITY STANDARDS. THE STORING OF GOOD AND MATERIALS ON SIDEWALK AND/ OR STREET SHALL NOT BE ALLOWED UNLESS THE CONTRACTOR HAS APPLIED AND SECURED A SPECIAL PERMIT WHICH ALLOW SUCH STORAGE TO BE PLACED.
- OWNERSHIP OF DRAWINGS: THESE DRAWINGS ARE THE PROPERTY OF GKW ARCHITECTS - GORDON WONG, ARCHITECT. THE DRAWINGS SHALL NOT BE USED FOR ANY OTHER PURPOSE EXCEPT AS APPROVED BY THE ARCHITECT.
- LIMITATION OF THE WORK: THE LIMITS OF THE WORK ARE ESTABLISHED BY THE DRAWINGS. THE CONTRACTOR SHALL BE RESPONSIBLE FOR COORDINATING TRADESMEN WITH THESE LIMITS.
- ANY EXISTING TO REMAIN SHALL BE IN GOOD CONDITION PRIOR TO THE PLANNING FINAL INSPECTION.
- NEW LANDSCAPING SHALL COMPLY WITH STATE WATER EFFICIENCY STANDARDS.

REVIEWED
By William Saxton at 6:33 am, May 05, 2020

Graphic Symbols

ASPHALT CONCRETE		BUILDING SECTION		WALL TYPE		INTERIOR ELEVATION		CLEAN OUT BOX	
PERMEABLE PAVERS		DATUM REFERENCE		WINDOW TYPE		REMOVE		STANDARD HOUSE SEWER	
EARTH		DETAIL REFERENCE		FIRE HYDRANT		DOMESTIC WATER METERS		BACK FLOW PREVENTOR	
SAND		DOOR TYPE		ROOM TAGS		IRRIGATION WATER METER			
RIGID INSULATION		WALL TYPE		CATCH BASIN		SANITARY SEWER MANHOLE			
DEMO EX. PARTS		KEYNOTE		STORM DRAIN PERFORATED TUBE					
FIRE ACCESS		REVISION		APPROXIMATE LINE OF WORK					



WILLIAM J. JENNY C. WONG & DANIA BAHAMONDA, DESIGNER
GKW ARCHITECTS, INC.
710E MCCLINCY LANE SUITE 109, CAMPBELL, CA 95008
(408) 796-1845 | WWW.GKWARCHITECTS.COM



396 Third Ave
Mixed-Use Development
396 Third Ave, Redwood City, CA 94063

Rev. #	Date	Description
1	2019.10.31	Planning, Geo., PW
2	2019.10.31	File
3	2020.02.05	File

Architectural Notes

A001

SCALE 1/32" = 1'-0"

2/6/2020 9:57:17 AM

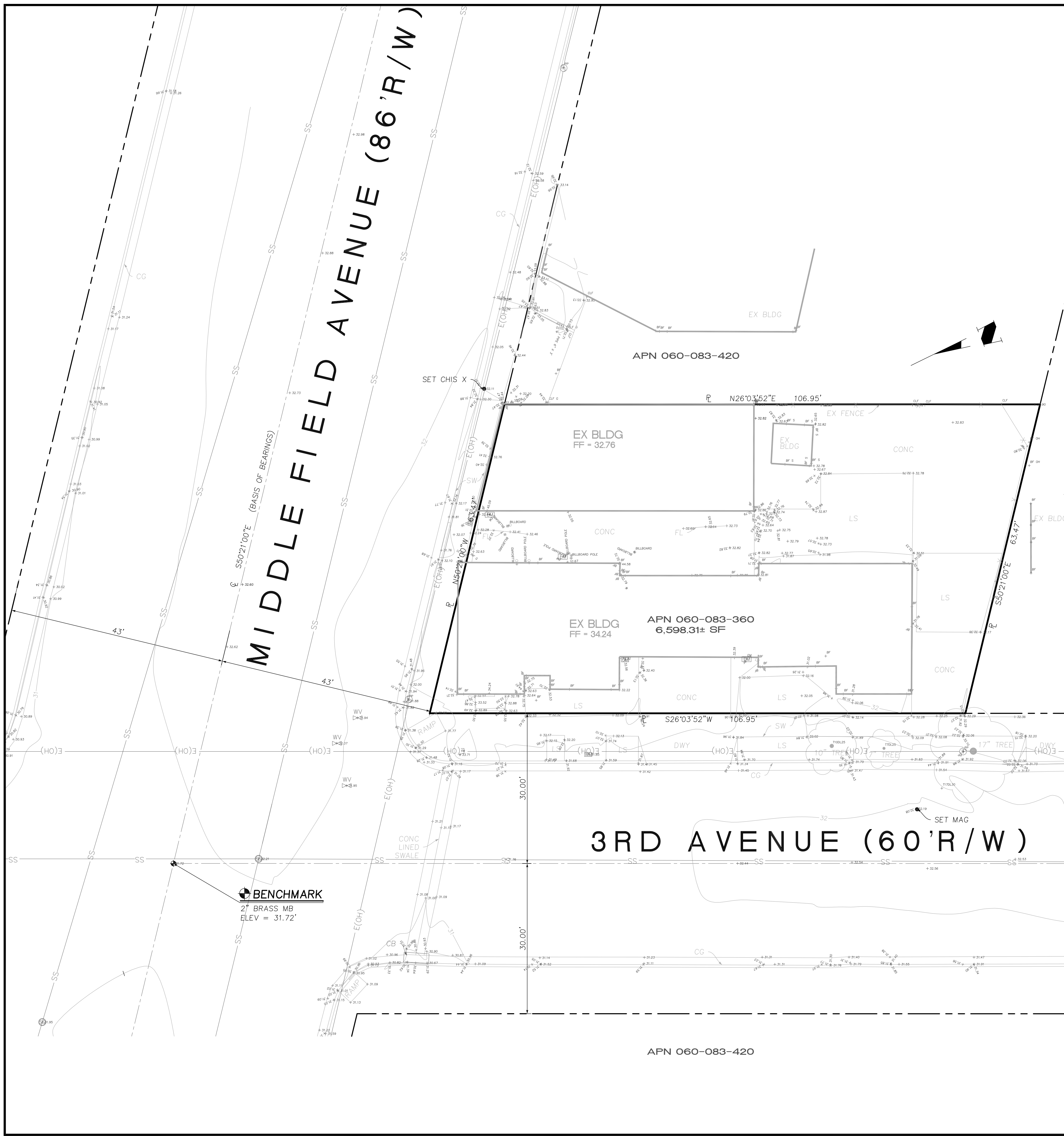

LEGEND & ABBREVIATIONS

AB	AGGREGATE BASE	FG	GROUND FINISH GRADE	REM	REMOVE
AC	ASPHALT CONCRETE	FH	FIRE HYDRANT	R/W	RIGHT OF WAY
AD	AREA DRAIN	FL	FLOW LINE	SD	STORM DRAIN
AE	ANCHOR EASEMENT	G	GARAGE SLAB	SDE	STORM DRAIN EASEMENT
BB	BUBBLER BOX	ELEVATION/GAS LINE	SE	SLOPE EASEMENT	
BD	BRASS DISC	GENERAL PUBLIC EASEMENT	SME	SLOPE MAINTENANCE EASEMENT	
BLDG	BUILDING	GSE	GRADING SETBACK	SS	SANITARY SEWER/LATERAL
BLK	BLOCK	GM	GAS METER	SSE	SANITARY SEWER EASEMENT
BSL	BUILDING SETBACK LINE	HP	HI POINT	STA	STATION
BW	BOTTOM OF WALL/BACK OF WALK	INV	INVERT	STD	STANDARD CITY DETAIL
CB	CATCH BASIN	LIP	LIP OF GUTTER	SW	SIDEWALK
CG	CURB & GUTTER	LS	LANDSCAPED AREA	TB	TOP OF BANK
CL	CENTERLINE	MAX	MAXIMUM	TC	TOP OF CURB
CLF	CHAIN LINK FENCE	MH	MANHOLE	TEMP	TEMPORARY
CO	SANITARY SEWER CLEANOUT	MIN	MINIMUM	TOC	TOP OF COVER
COP	CURB OPENING	MON	MONUMENT	TOE	TOE OF BANK
CONC	CONCRETE	MW	MONUMENT WELL	TG	TOP OF GRATE
CSD	COUNTY STANDARD DETAIL	N&S	NAIL AND SHINER	TH	TREE PROTECTION FENCE
CVE	CONSERVATION EASEMENT	NTS	NOT TO SCALE	TW	TOP OF WALL
DE	DRAINAGE EMITTER	OH	OVERHEAD	TYP	TYPICAL
DI	DRAINAGE INLET	OG	ORIGINAL GROUND	UV	UTILITY VAULT
DS	DOWNSPOUT	P	PAVEMENT FINISH GRADE	VG	VALLEY GUTTER
DWY	DRIVEWAY	PAD	PAD ELEVATION	W	WATER
EA	EASEMENT	PE	PATHWAY EASEMENT	WCE	WIRE CLEARANCE EASEMENT
ELEV	ELEVATION	PEE	PEDESTRIAN EQUESTRIAN EASEMENT	WLK	WALKWAY
EM	ELECTRIC METER	PERF	PERFORATED	WM	WATER METER
E(OH)	ELECTRIC OVERHEAD	PP	PROPERTY LINE	WOE	WIRE OVERHANG EASEMENT
E(UG)	ELECTRIC UNDERGROUND	PROP	PROPER POLE	WV	WATER VALVE
EP	EDGE OF PAVEMENT	PSE	PROPOSED		
EX	EXISTING	PSUE	PUBLIC SERVICE EASEMENT		
EVA	VEHICLE ACCESS EASEMENT	PUE	PUBLIC SERVICE UTILITY EASEMENT		
FC	FACE OF CURB	PVMT	PAVEMENT		
FD	FOUND	PVC	POLYVINYL CHLORIDE		
FF	FINISH ELEVATION OF SUBFLOOR	R	RADIUS		
FL	FLOW LINE	RW	RETAINING WALL		

⊙	AREA DRAIN	⊙	GAS METER	⊙	ROCK RETAINING WALL
+	BENCHMARK	⊙	GAS VALVE	⊙	RIGHT OF WAY
—	BOUNDARY	⊙	GUY POLE	⊙	SANITARY SEWER CLEAN OUT MANHOLE
⊠	CATCH BASIN	⊙	GUY WIRE ANCHOR	⊙	SANITARY SEWER MANHOLE
□	CONCRETE	⊙	HYDRANT: EXISTING	⊙	STORM DRAIN MANHOLE
—550—	EXISTING CONTOUR	⊙	INLET	⊙	ELECTRICAL BOX
—	DRAINAGE SWALE	⊙	JOINT POLE	⊙	ELECTRIC METER
---	EASEMENT LINE	⊙	LIGHTING	⊙	TELEPHONE BOX
+101.70 OR (101.70)	EXISTING ELEVATION	⊙	LIGHTING POLE	⊙	TELEVISION BOX
—X—	EXISTING FENCE	⊙	MAIL BOX	⊙	UTILITY: EXISTING
⊙	EXISTING TREE	⊙	MONUMENT WELL	⊙	WATER METER
•	FOUND IRON PIPE	⊙	PGE BOX	⊙	WATER VALVE WELL
		★	PROJECT SITE		

BASIS OF BEARINGS

THE BEARINGS SHOWN ON THIS MAP ARE BASED ON THE CENTER LINE ON MIDDLEFIELD AVENUE, AS FOUND MONUMENTED AS S50°21'00"E ON THE RECORD OF SURVEY, RECORDED IN VOLUME 14 PAGE 147, SAN MATEO COUNTY RECORDS.

NOTES

- PHYSICAL ITEMS SHOWN ON THIS SURVEY ARE LIMITED TO THOSE SURFACE ITEMS VISIBLE AS OF THE DATE OF THIS SURVEY AND FROM AVAILABLE RECORD DATA. SUBSURFACE OBJECTS, IF ANY, MAY NOT BE SHOWN. SAID SUBSURFACE OBJECTS MAY INCLUDE, BUT ARE NOT LIMITED TO, UNDERGROUND, UTILITY LINES, UTILITY VAULTS, CONCRETE FOOTINGS, SLABS, SHORING, STRUCTURAL PILES, PIPING, UNDERGROUND TANKS, AND ANY OTHER SUBSURFACE STRUCTURES NOT REVEALED BY A SURFACE INSPECTION.
- DIMENSIONS SHOWN HEREON ARE GROUND DISTANCES IN FEET AND DECIMALS THEREOF.
- NO PROPERTY CORNERS ARE PROPOSED TO BE SET BY THIS SURVEY.
- ASSESSOR'S PARCEL NUMBER: 060-083-360
- TREE TRUNK LOCATIONS ARE APPROXIMATE. TREES THAT CROSS A PROPERTY LINE AT GROUND LEVEL SHOULD BE CONSIDERED TO BE JOINTLY OWNED BY THE RESPECTIVE PROPERTY OWNERS. CONSULT AN ARBORIST FOR DETAILS.
- DIMENSIONS FROM HOUSE TO PROPERTY LINE ARE MEASURED FROM THE BUILDING FACE OF THE STRUCTURE, PERPENDICULAR TO THE PROPERTY LINES.

SURVEYOR'S STATEMENT

THIS BOUNDARY SURVEY AND TOPOGRAPHIC MAP WAS PREPARED BY ME OR UNDER MY DIRECTION.

Tom H. Milo
TOM H. MILO
L.S. 6438
11/08/18
DATE



ENGINEERING 598 E Santa Clara St, #270 San Jose, CA 95112 Phone: (408) 806-7187 Fax: (408) 583-4006		11/08/18 DESIGNED DATE 11/08/18 DRAWN DATE 11/08/18 SCALE 1" = 10' CHECKED DATE	REVISIONS NO. DATE APP'D BY
BOUNDARY SURVEY AND TOPOGRAPHIC MAP 396 3RD AVENUE APN 060-083-360		PROJECT NO. CONTRACT NO.	REDWOOD CITY California
DRAWING NO. 1 SHT NO.	OF 1	FILE NO.	NO.

APPLICANT :

ROAD NAME : 3RD AVENUE

FILE NO :

GRADING AND DRAINAGE IMPROVEMENTS

- ELEVATIONS AND LOCATIONS OF ALL EXISTING UTILITY CROSSINGS SHALL BE VERIFIED BY THE CONTRACTOR PRIOR TO START OF ANY CONSTRUCTION AFFECTING SAID LINES. CONTACT USA AT (800) 642-2444 AT LEAST TWO WORKING DAYS PRIOR TO EXCAVATION.
- ALL APPLICABLE WORK AND MATERIALS SHALL BE DONE IN ACCORDANCE WITH THE COUNTY OF SAN MATEO STANDARD TECHNICAL SPECIFICATIONS AND DETAILS.
- THE CONTRACTOR SHALL RESTORE ALL DAMAGED, REMOVED OR OTHERWISE DISTURBED WALLS, FENCES, SERVICES, UTILITIES, IMPROVEMENTS OR FEATURES OF WHATEVER NATURE, DUE TO CONTRACTOR'S WORK.
- THE CONTRACTOR SHALL COORDINATE HIS WORK WITH THE INSTALLATION OF FACILITIES BY PG&E, PACIFIC BELL, AND CABLE TV INSTALLATION. VALVE BOXES AND MANHOLES, AND STRUCTURES TO BE SET TO GRADE IN CONCRETE AFTER PAVING.
- ALL STREETS MONUMENTS AND OTHER PERMANENT MONUMENTS DISTURBED DURING THE PROCESS OF CONSTRUCTION SHALL BE REPLACED BEFORE ACCEPTANCE OF THE IMPROVEMENTS BY THE COUNTY ENGINEER.
- THE CONTRACTOR SHALL GIVE THE COUNTY ENGINEER TWO WORKING DAYS ADVANCE NOTICE FOR INSPECTION. (650) 363-1852.
- NO TREES 12" DIAMETER OR LARGER MEASURED BETWEEN 6" AND 36" ABOVE GRADE, SHALL BE REMOVED WITHOUT PERMIT FROM SAN MATEO COUNTY.
- FOR LANE CLOSURES, THE CONTRACTOR SHALL PREPARE A TRAFFIC CONTROL PLAN AND OBTAIN APPROVAL OF THE COUNTY ENGINEER BEFORE COMMENCING WORK. THE CONTRACTOR SHALL PROVIDE FLAGMEN, CONES OR BARRICADES, AS NECESSARY TO CONTROL TRAFFIC AND PREVENT HAZARDOUS CONDITIONS PER THE CALIFORNIA STANDARD PLANS, SPECIFICATIONS, AND MANUAL ON TRAFFIC CONTROL DEVICES, LATEST EDITION.
- PEDESTRIAN, PUBLIC ACCESSES, WHEELCHAIR ACCESSES SHALL BE MAINTAINED DURING THE CONSTRUCTION TO THE SATISFACTION OF THE COUNTY ENGINEER.
- NO TRENCHES OR HOLES SHALL BE LEFT OPEN OVERNIGHT; USE STEEL PLATING OR HOT MIX ALPHALT AS REQUIRED TO PROTECT OPEN TRENCHES OVERNIGHT.
- THE CONTRACTOR SHALL CONTROL DUST AT ALL TIMES AND SWEEP STREETS AS OFTEN AS NECESSARY DURING THE CONSTRUCTION AS REQUIRED BY THE COUNTY ENGINEER.
- ALL REVISIONS TO THIS PLAN MUST BE REVIEWED AND APPROVED BY THE COUNTY ENGINEER PRIOR TO CONSTRUCTION AND SHALL BE ACCURATELY SHOWN REVISED PLANS STAMPED AND SIGNED BY COUNTY ENGINEER PRIOR TO THE INSTALLATION OF THE IMPROVEMENTS.
- ALL CONSTRUCTIONS STAKING FOR CURB, GUTTER, SIDEWALK, SANITARY SEWERS, STORM DRAINS, WATER LINES, FIRE HYDRANTS, ELECTROLIERS, ETC., SHALL BE DONE BY A REGISTERED CIVIL ENGINEER OR LICENSED LAND SURVEYOR.
- SEWER CLEAN-OUT**
LOCATE AND EXPOSE EXISTING SEWER CLEAN-OUT. IF THERE IS NO EXISTING SEWER LEAN-OUT, CONTRACTOR TO INSTALL A NEW SEWER CLEAN-OUT AT 3 FEET MAXIMUM FROM THE PRIVATE SIDE OF THE PROPERTY LINE PER COUNTY SEWER DISTRICT STANDARDS.
- CURB & GUTTER, SIDEWALK, DRIVEWAY**
CONTRACTOR TO REPLACE ALL EXISTING CURB, GUTTER AND SIDEWALK ADJACENT TO THE PROPERTY THAT ARE DAMAGED BEFORE OR DURING CONSTRUCTION TO COUNTY STANDARDS. A SEPARATE PERMIT IS REQUIRED FOR WORK IN THE PUBLIC RIGHT-OF-WAY.
- WATER SERVICE AND METER**
CONTACT CALIFORNIA WATER SERVICE COMPANY AT (650) 558-7800 FOR ALL WATER SERVICES MATTERS, ESPECIALLY FOR METER AND PIPE UPGRADE DUE TO NEW SPRINKLER SYSTEM INSTALLATION. METER SIZE TO BE DETERMINED BY FIRE-FLOW CALCULATIONS.
- STORM WATER POLLUTION PREVENTION**
THE CONTRACTOR IS ADVISED THAT THE COUNTY OF SAN MATEO AND ALL OTHER MUNICIPAL STORM WATER DISCHARGERS IN SAN MATEO COUNTY ARE CO-PERMITTEES UNDER THE NATIONAL POLLUTANT DISCHARGE ELIMINATION SYSTEM (NPDES) PERMIT NUMBER CA 0029921. THIS PERMIT PROHIBITS THE DISCHARGE OF ILLICIT DISCHARGES (NON RAINWATER) INTO THE STORM DRAIN SYSTEM, UNLESS SPECIFICALLY EXEMPT. AS A CONDITION OF THIS PERMIT THE COUNTY OF SAN MATEO AND SAN MATEO COUNTY HAVE IMPLEMENTED A LOCAL STORM WATER MANAGEMENT PLAN, ADOPTED RESPECTIVE ENABLING ORDINANCES PROHIBITING ILLICIT DISCHARGES, AND ADOPTED "BEST MANAGEMENT PRACTICES" (BMPs) TO ASSIST CONTRACTORS AND CITIZENS WITH ALTERNATIVES. THE CENTRAL GOAL OF THE STORM WATER MANAGEMENT PLAN AND BMPs IS TO REDUCE THE AMOUNT OF POLLUTION IN RUN-OFF AND ESTABLISH PROCEDURES TO ADDRESS AND CONTROL STORM WATER POLLUTION RESULTING FROM BOTH PUBLIC AND PRIVATE SECTOR CONSTRUCTION ACTIVITY WITHIN THE COUNTY. THE TYPES OF CONSTRUCTION CONTRACTS CONTROLLED BY THIS SECTION INCLUDE SITE IMPROVEMENT WORK, STREET AND UTILITY REPLACEMENT OR IMPROVEMENT, DRAINAGE WORK, AND GENERAL CONSTRUCTION. ALL WORK PERFORMED UNDER THIS CONTRACT AND ALL CONTRACTOR'S AND THEIR ASSOCIATES AND/OR EMPLOYEES ARE REQUIRED TO COMPLY WITH ALL APPLICABLE STORM WATER REGULATIONS AND TO IMPLEMENT BMPs AT ALL TIMES. GUIDELINES AND BMPs ARE AVAILABLE FROM THE COUNTY OF SAN MATEO PUBLIC WORKS SERVICES DEPARTMENT.
- UNDERGROUND UTILITY SERVICES**
CONTRACTOR SHALL UNDERGROUND UTILITY SERVICES (I.E. ELECTRIC, TELEPHONE, CATV, ETC.) FROM THE NEAREST UTILITY POLE(S) IN THE STREET TO THE HOUSE.
- WORK IN THE PUBLIC RIGHT-OF-WAY AND EASEMENT**
CONTRACTOR SHALL APPLY AND OBTAIN AN ENCROACHMENT FROM SAN MATEO COUNTY PERMIT FOR ALL WORK IN THE PUBLIC RIGHT-OF-WAY AND EASEMENT.
- NO PARKING IN THE PUBLIC RIGHT-OF-WAY**
PARKING FOR CONSTRUCTION AND PERSONNEL VEHICLES, AND EQUIPMENT OF ANY KIND WILL NOT BE PERMITTED ON THE PUBLIC RIGHT-OF-WAY AND EASEMENT.
- SOIL ENGINEER TO PROVIDE FINAL LETTER OF INSPECTION AT COMPLETION OF THE GRADING IN ACCORDANCE WITH THE CALIFORNIA BUILDING CODE 2016.
- CONTRACTOR SHALL GRADE EVENLY BETWEEN SPOT ELEVATIONS SHOWN.
- ALL WORK SHALL BE PERFORMED IN ACCORDANCE WITH APPLICABLE O.S.H.A. REGULATIONS.
- CONTRACTOR TO VERIFY ALL EXISTING INVERT ELEVATIONS FOR STORM DRAIN CONSTRUCTION PRIOR TO ANY SITE WORK. SHOULD DISCREPANCIES EXIST BETWEEN THE ACTUAL ELEVATIONS AND LOCATIONS OF EXISTING STORM DRAIN CONNECTIONS AND THOSE AS SHOWN ON THESE PLANS, THE CONTRACTOR SHALL NOTIFY ENGINEER OF WORK BEFORE ADJUSTING THE DESIGN.
- CONTRACTOR SHALL UNCOVER AND EXPOSE ALL EXISTING UTILITY, SEWER AND STORM DRAIN LINES WHERE THEY ARE TO BE CROSSED ABOVE OR BELOW BY THE NEW FACILITY BEING CONSTRUCTED IN ORDER TO VERIFY THE GRADE AND TO ASSURE THAT THERE IS SUFFICIENT CLEARANCE. HE OR SHE SHALL CALL THE ENGINEER OF WORK REGARDING POTENTIAL CONFLICTS BEFORE FIELD WORK BEGINS.
- APPROVAL OF THIS PLAN APPLIES ONLY TO THE EXCAVATION, PLACEMENT AND COMPACTION OF NATURAL EARTH MATERIALS. THIS APPROVAL DOES NOT CONFER ANY RIGHTS OF ENTRY TO EITHER PUBLIC PROPERTY OR THE PRIVATE PROPERTY OF OTHERS. APPROVAL OF THIS PLAN ALSO DOES NOT CONSTITUTE APPROVAL OF ANY IMPROVEMENTS. PROPOSED IMPROVEMENTS ARE SUBJECT TO REVIEW AND APPROVAL BY THE RESPONSIBLE AUTHORITIES AND ALL OTHER REQUIRED PERMITS SHALL BE OBTAINED.
- ALL CONSTRUCTION SHALL COMPLY WITH SECTION 24 OF THE STATE OF CALIFORNIA ADMINISTRATIVE CODE AND CHAPTERS 10 AND 11 OF THE CALIFORNIA BUILDING CODE 2016.
- EARTHWORK QUANTITIES SHOWN ON THESE PLANS ARE ONLY TO BE USED TO DETERMINE THE AMOUNT OF THE GRADING PERMIT.
- ADJUSTMENTS TO BUILDING PAD ELEVATIONS OR PARKING LOT GRADES TO ACHIEVE EARTHWORK BALANCE SHALL BE MADE ONLY WITH APPROVAL OF THE ENGINEER.
- SOIL ENGINEER WILL NOT DIRECTLY CONTROL THE PHYSICAL ACTIVITIES OF THE CONTRACTOR OR ANY SUBCONTRACTORS OF THE CONTRACTOR OR SUBCONTRACTOR'S WORKMEN'S ACCOMPLISHMENT OF WORK ON THE PROJECT. CONTRACTOR WILL BE SOLELY AND COMPLETELY RESPONSIBLE FOR WORKING CONDITIONS ON THE JOB SITE, INCLUDING SAFETY OF ALL PERSONS AND PROPERTY DURING PERFORMANCE OF THE WORK. THIS REQUIREMENT WILL APPLY CONTINUOUSLY AND NOT BE LIMITED TO NORMAL WORKING HOURS.

GRADING AND DRAINAGE PLAN

396 3RD AVENUE, REDWOOD CITY CA 94063

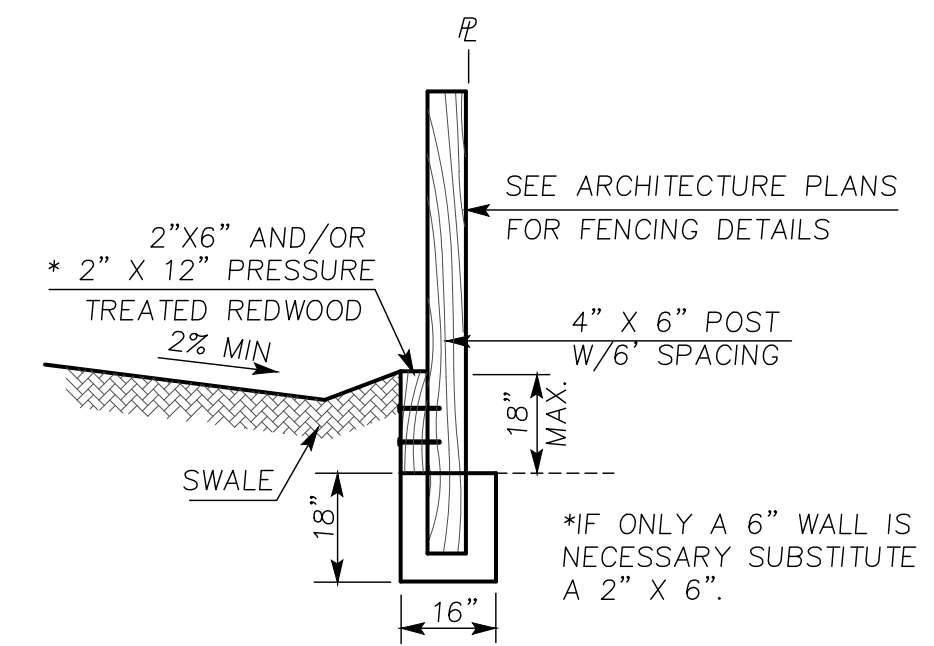

18" MAX. WALL/FENCE DETAIL @ PERIMETER DETAIL A
NTS

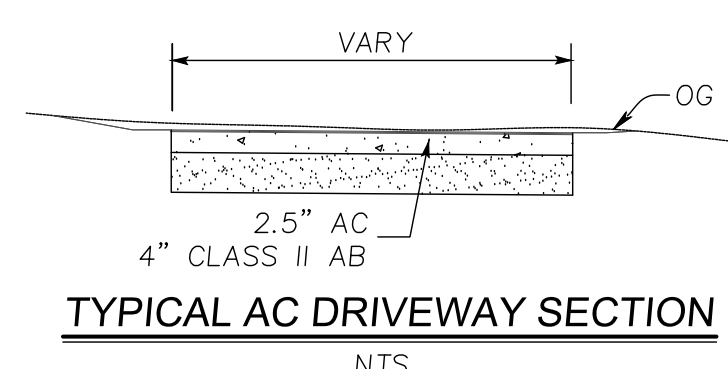

TYPICAL AC DRIVEWAY SECTION
NTS

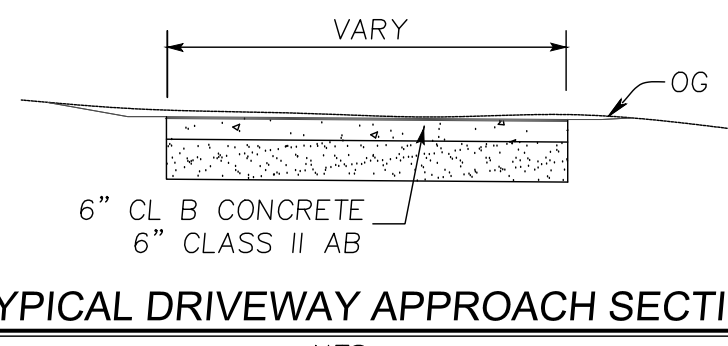

TYPICAL DRIVEWAY APPROACH SECTION
NTS

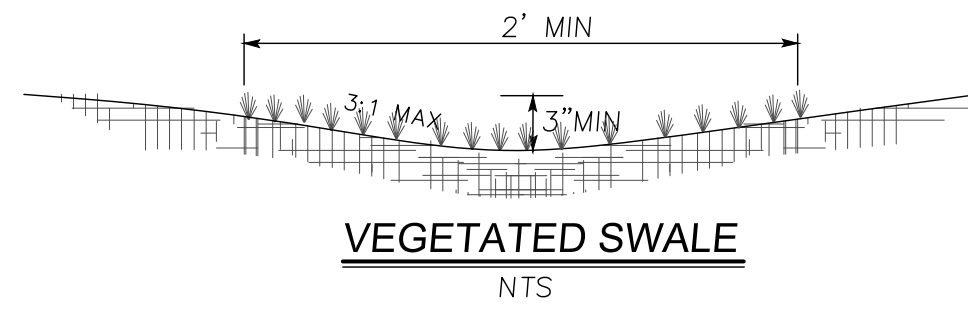

VEGETATED SWALE
NTS

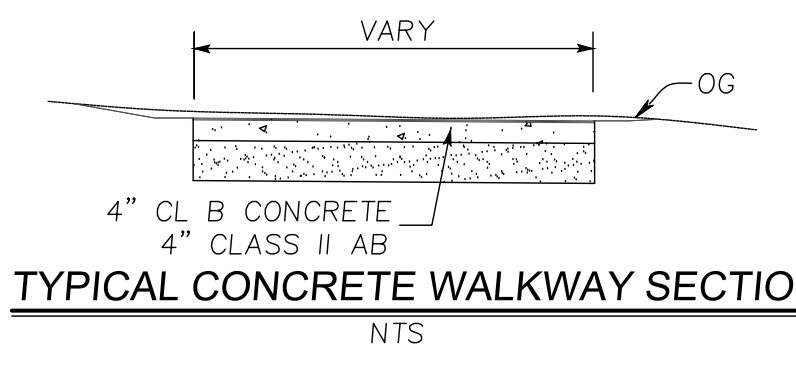

TYPICAL CONCRETE WALKWAY SECTION
NTS

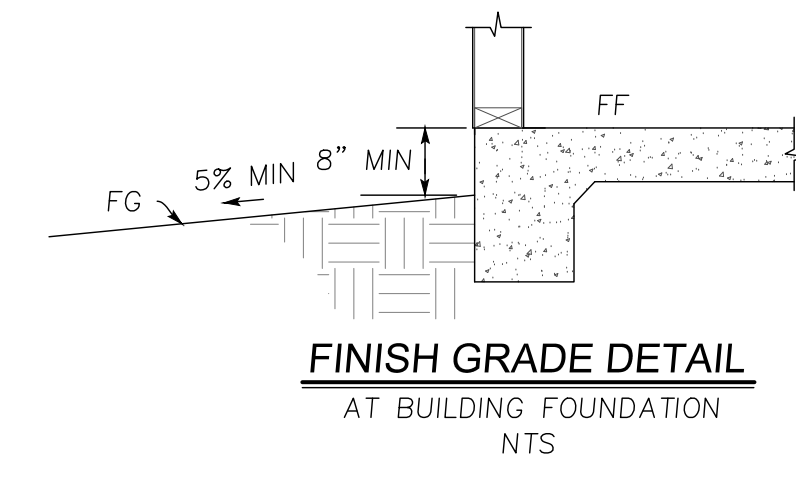

FINISH GRADE DETAIL AT BUILDING FOUNDATION
NTS

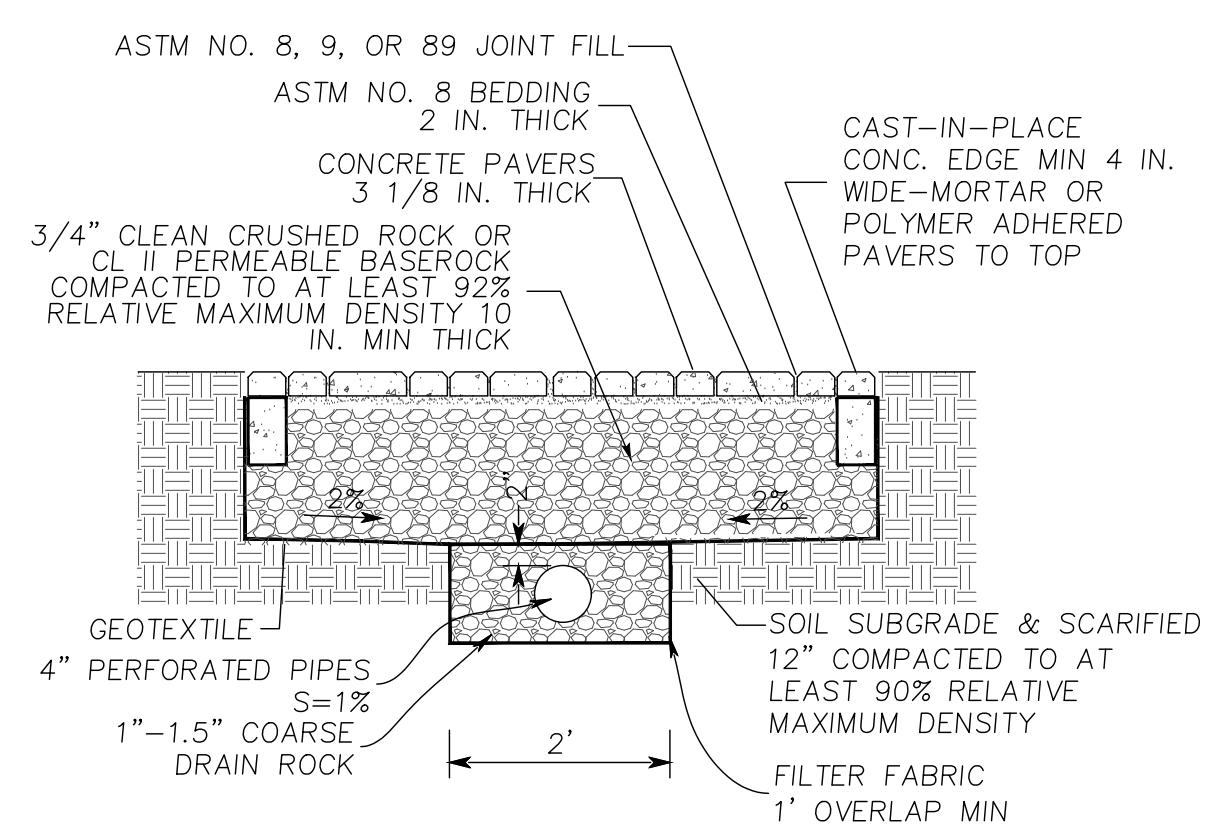

TYPICAL PERMEABLE CONCRETE PAVER DRIVEWAY SECTION
NTS

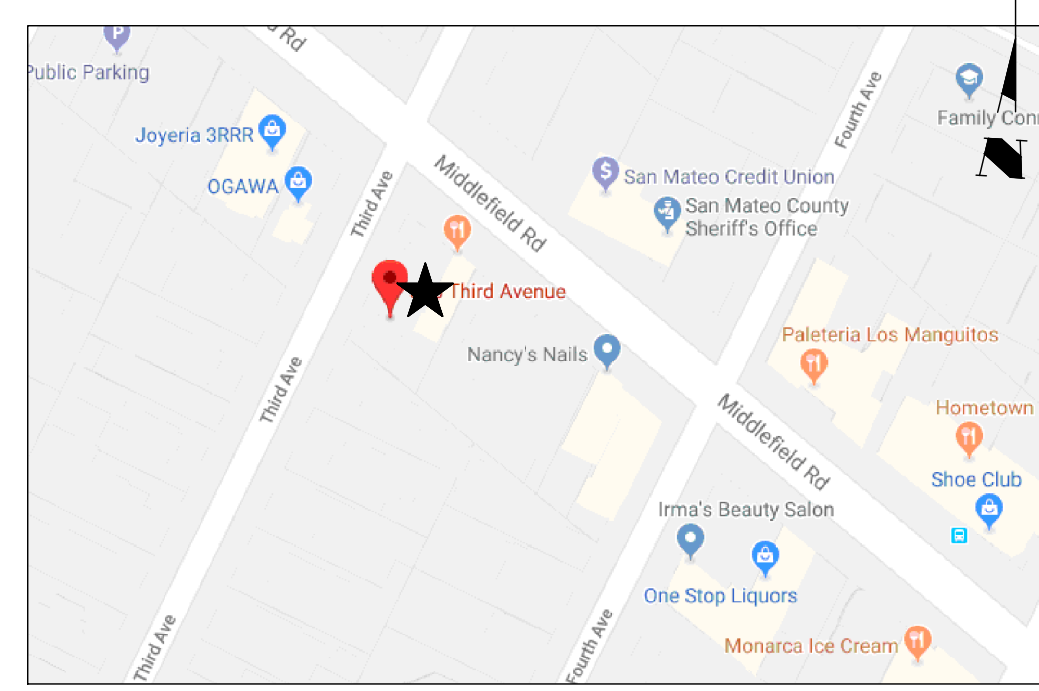

LOCATION MAP
NTS

BASIS OF BEARINGS

THE BEARINGS SHOWN ON THIS MAP ARE BASED ON THE CENTER LINE ON MIDDLEFIELD AVENUE, AS FOUND MONUMENTED AS S50°21'00"E ON THE RECORD OF SURVEY, RECORDED IN VOLUME 14 PAGE 147, SAN MATEO COUNTY RECORDS.

BENCHMARK

2" BRASS MB
ELEV = 31.72'

SCOPE OF WORK

GRADE DRIVEWAY & HOUSE SITE; INSTALL DRAINAGE FACILITIES, EROSION AND SEDIMENT CONTROL, DRIVEWAY AND DRIVEWAY APPROACH, DRAINAGE IMPROVEMENTS; & SEED ALL DISTURBED AREAS

SHEET INDEX

SHEET C1	TITLE SHEET
SHEET C2	DEMOLITION PLAN
SHEET C3	GRADING, DRAINAGE PLAN
SHEET C4	BUILDING CROSS SECTIONS
SHEET C5	EROSION CONTROL PLAN & CONSTRUCTION OPERATION PLAN
SHEET C6	BLUE PRINT FOR A CLEAN BAY COUNTY STANDARD DETAILS
SHEET C7	

LEGEND & ABBREVIATIONS

AB	AGGREGATE BASE	FD	FOUND FINISH ELEVATION OF SUBFLOOR	R	RADIUS	⊗	AREA DRAIN	⊗	HYDRANT: PROPOSED OR NEW
AC	ASPHALT CONCRETE	FF	FINISH ELEVATION OF SUBFLOOR	RW	RETAINING WALL	⊗	BENCHMARK	⊗	INLET 9"x9"
AD	AREA DRAIN	FG	GROUND FINISH GRADE	REM	REMOVE	⊗	BOUNDARY	⊗	JOINT POLE
AE	ANCHOR EASEMENT	FH	FIRE HYDRANT	R/W	RIGHT OF WAY	⊗	CATCH BASIN	⊗	LIGHTING
BB	BUBBLER BOX	FL	FLOW LINE	SD	STORM DRAIN	⊗	COBBLE ROCK ENERGY DISSIPATOR	⊗	LIGHTING POLE
BLDG	BUILDING	G	GARAGE SLAB ELEVATION/GAS LINE	SDE	STORM DRAIN EASEMENT	⊗	CONCRETE	⊗	OVERLAND FLOW DIRECTION
BSL	BUILDING SETBACK LINE	GPE	GENERAL PUBLIC EASEMENT	SE	SLOPE EASEMENT	⊗	CONTOUR: EXISTING	⊗	PGE BOX
BW	BOTTOM OF WALL/BACK OF WALK	GSB	GRADING SETBACK	SM	STANDARD DETAIL	⊗	CONTOUR: PROPOSED OR NEW	⊗	POST CONSTRUCTION STORM WATER POLLUTION CONTROL MEASURE
CD	COBBLE ROCK ENERGY DISSIPATOR	GM	GAS METER	SS	SANITARY SEWER/LATERAL	⊗	DESIGN GRADE	⊗	PROJECT SITE
CG	CURB & GUTTER	HP	HI POINT	SSE	SANITARY SEWER EASEMENT	⊗	DOWNSPOUT	⊗	RETAINING WALL
CL	CENTERLINE	INV	INVERT	STA	STATION	⊗	DOWNSPOUT WITH SPLASHBLOCK	⊗	RIGHT OF WAY
CLF	CHAIN LINK FENCE	LIP	LIP OF GUTTER	STD	STANDARD DETAIL	⊗	DRAINAGE EMITTER	⊗	SANITARY SEWER CLEAN OUT MANHOLE
CO	SANITARY SEWER CLEANOUT	LS	LANDSCAPED AREA MAXIMUM	STD	STANDARD DETAIL	⊗	DIVERSION VALVE	⊗	SANITARY SEWER MANHOLE
COP	CURB OPENING	MH	MANHOLE	SW	SIDEWALK	⊗	BACKWATER VALVE	⊗	STORM DRAIN MANHOLE
CONC	CONCRETE	MIN	MINIMUM	TB	TOP OF BANK	⊗	DRAINAGE SWALE	⊗	SUMP PUMP
CSD	COUNTY STANDARD DETAIL	N&S	NAIL AND SILVER	TC	TOP OF CURB	⊗	EASEMENT LINE	⊗	TELEPHONE BOX
DE	DRAINAGE EMITTER	NTS	NOT TO SCALE	TEMP	TEMPORARY	⊗	EXISTING ELEVATION	⊗	TELEVISION BOX
DI	DRAINAGE INLET	OG	ORIGINAL GROUND	TOC	TOP OF COVER	⊗	EXISTING FENCE	⊗	TEST PIT
DS	DOWNSPOUT	OG	ORIGINAL GROUND	TOE	TOE OF BANK	⊗	EXISTING TREE TO BE REMOVED	⊗	TOP OF FILL
DWY	DRIVEWAY	P	PAVEMENT FINISH GRADE	TG	TOP OF GRATE	⊗	EXISTING TREE TO REMAIN	⊗	TOE OF FILL
EA	EASEMENT	PAD	PAD ELEVATION	TPF	TREE PROTECTION FENCE	⊗	FOUND IRON PIPE AT PROPERTY CORNER	⊗	TOP OF CUT
ELEV	ELEVATION	R	PROPERTY LINE	TW	TOP OF WALL	⊗	FILTER FABRIC ROLLS	⊗	TOE OF CUT
EM	ELECTRIC METER	PEE	PEDESTRIAN EQUESTRIAN EASEMENT	TYP	TYPICAL	⊗	GAS METER	⊗	TREE NUMBER
E(OH)	ELECTRIC OVERHEAD	PERF	PERFORATED	VEG	VEGETATED	⊗	GAS VALVE	⊗	T-Vault
E(UG)	ELECTRIC UNDERGROUND	PP	POWER POLE PROP PROPOSED	VG	VALLEY GUTTER	⊗	GRADE TO DRAIN	⊗	UTILITY: EXISTING
EP	EDGE OF PAVEMENT	PSE	PUBLIC SERVICE EASEMENT	W	WATER	⊗	GUY POLE	⊗	UTILITY: PROPOSED OR NEW
EX	EXISTING	PUE	PUBLIC UTILITY EASEMENT	WCE	WIRE CLEARANCE EASEMENT	⊗	GUY WIRE ANCHOR	⊗	WATER METER
FC	FACE OF CURB	PVM	PAVEMENT	WLK	WALKWAY	⊗	HIGH POINT	⊗	WATER VALVE
		PVC	POLYVINYL CHLORIDE	WME	WIRE OVERHANG EASEMENT	⊗	HYDRANT: EXISTING	⊗	WELL

EARTHWORK QUANTITIES

CUT = 138 CY; MAXIMUM CUT DEPTH = 1.5'
 FILL = 0 CY; MAXIMUM FILL DEPTH = 0'
 IMPORT 0 CY
 EXPORT 138 CY

EARTHWORK QUANTITIES AS SHOWN ON THE PLAN IS FOR INFORMATION ONLY. CONTRACTOR TO CALCULATE HIS/HER OWN EARTHWORK QUANTITIES FOR BIDDING PURPOSE.

RECORD DRAWINGS (To be signed at project's completion)

These Record Drawings are based on limited field review and field surveys, as necessary by and we and The County of San Mateo assume no liability for the accuracy of the information.

"Prior to occupancy, a licensed civil engineer shall certify to the County engineer that the site has been graded to the elevations shown on the Plan, and that the site will drain properly."

(Signature) NINH LE (Date) R.C.E 47518

(Signature) NINH LE (Date) R.C.E 47518

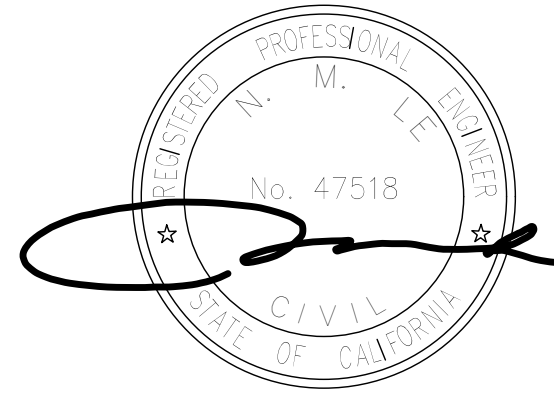

PER COUNTY'S COMMENTS DATED 02/21/19

DATE DESIGNED: 02/06/19
 DATE DRAWN: 02/06/19
 AS NOTED SCALE: N
 CHECKED: ML

DATE: 02/06/19

BY: DATE: APP'D: REVISIONS: NO.

ENGINEERING

598 E Santa Clara St #270
 San Jose, CA 95112
 Phone: (408) 806-7187
 Fax: (408) 583-4006

California

PROJECT NO. _____

TITLE SHEET
 396 3RD AVENUE
 APN 060-083-360

CONTRACT NO. _____

FILE NO. _____

DRAWING NO. **C1** OF 7

SHEET NO. **1** OF 7

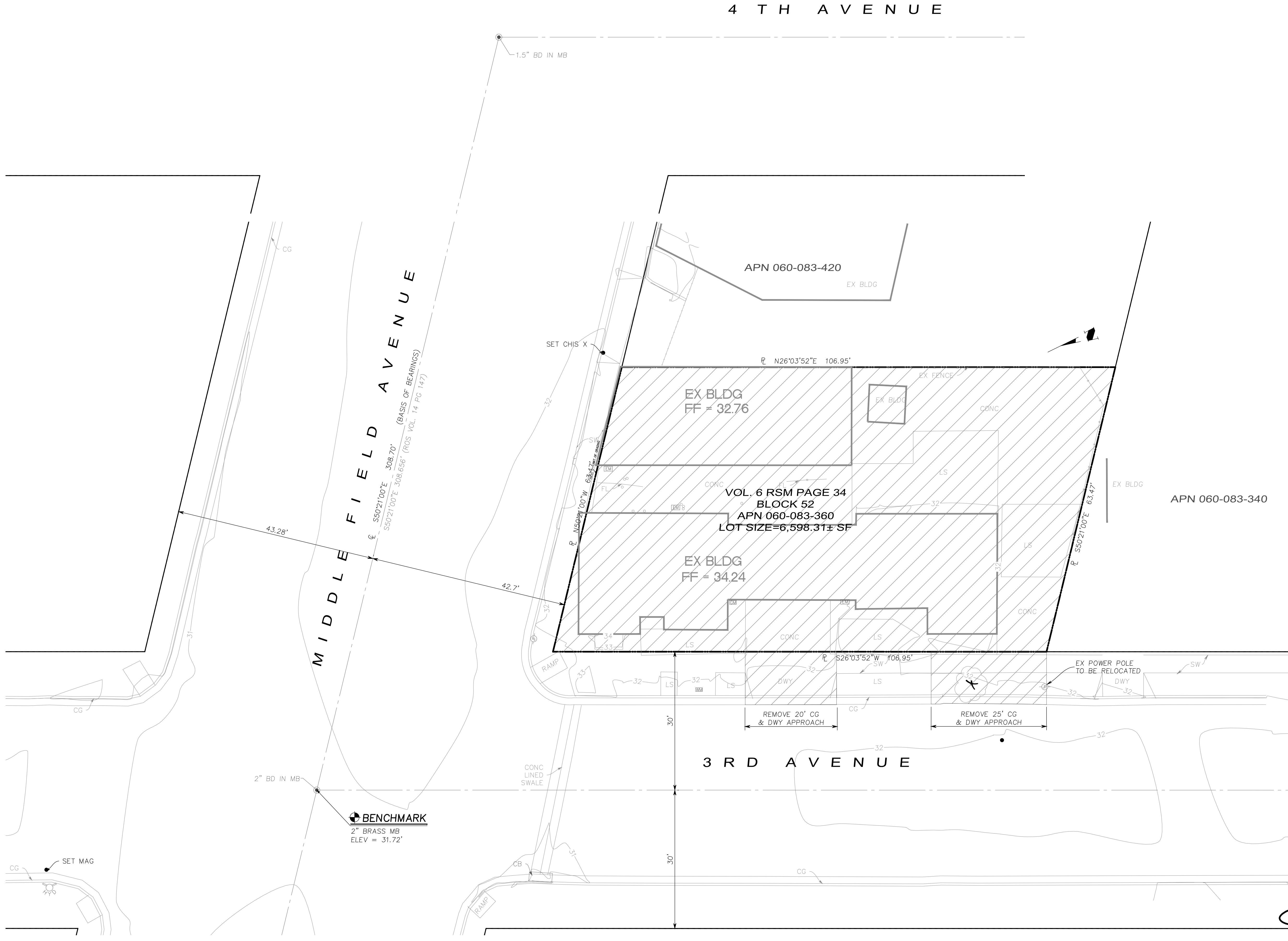

APPLICANT : NGUYEN

ROAD NAME : 3RD AVENUE

FILE NO :

ENGINEERING 598 E Santa Clara St #270 San Jose, CA 95112 Phone: (408) 806-7187 Fax: (408) 583-4006		PER COUNTY'S COMMENTS DATED 02/21/19
DESIGNED PT	DATE 02/06/19	NO.
DRAWN PT	DATE 02/06/19	NO.
SCALE 1"=10'	CHECKED ML	REVISIONS
BY	DATE	NO.
DEMOLITION PLAN 396 3RD AVENUE APN 060-083-360		PROJECT NO.
DRAWING NO. C2	CONTRACT NO.	FILE NO.
SHEET NO. 2 OF 7	Redwood City	California

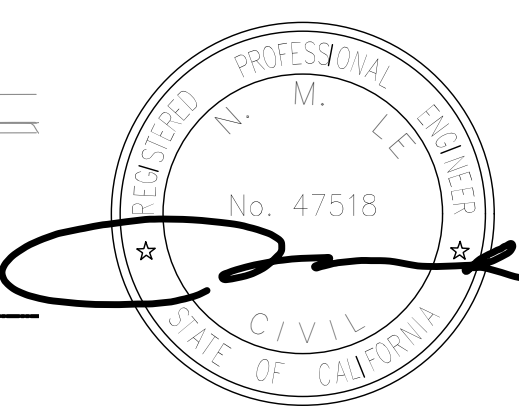
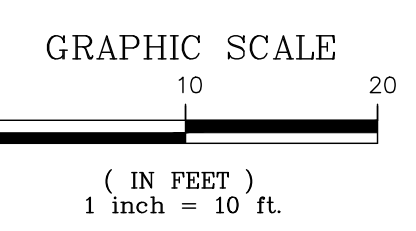

SANITARY SEWER NOTES:

1. SANITARY SEWER CONNECTION AND TESTING MUST BE MADE IN THE PRESENCE OF A SEWER DISTRICT REPRESENTATIVE.
2. THE SEWER DISTRICT OFFICE SHALL BE CONTACTED (650-363-4100) TO SCHEDULE INSPECTIONS. INSPECTIONS MUST BE SCHEDULED A MINIMUM OF ONE WORKING DAY PRIOR TO THE INSPECTION. NO INSPECTIONS SHALL OCCUR ON FRIDAYS, WEEKENDS OR HOLIDAYS UNLESS SPECIAL ARRANGEMENTS ARE MADE WITH THE SEWER DISTRICT.
3. CARE MUST BE TAKEN TO PROTECT THE EXISTING SEWER DISTRICT FACILITIES WHEN A NEW SEWER LATERAL AND CONNECTION IS INSTALLED. ANY DAMAGE TO THE SEWER DISTRICT FACILITIES DURING THE INSTALLATION OF THIS NEW LATERAL SHALL BE REPAIRED BY THE APPLICANT PER THE SEWER DISTRICT STANDARD DETAILS AND AT THE APPLICANT'S EXPENSE. THE SEWER DISTRICT MUST BE NOTIFIED OF ANY DAMAGES TO THE SANITARY SEWER FACILITIES AND ANY REPAIRS MUST BE INSPECTED BY A SEWER DISTRICT REPRESENTATIVE.
4. A VIDEO INSPECTION OF THE SEWER MAIN (MANHOLE TO MANHOLE) WHERE THE NEW LATERAL CONNECTS TO THE SEWER DISTRICT MAIN OR THE EXISTING CONNECTION IS TO BE REMOVED SHALL BE PERFORMED BY THE APPLICANT OR CONTRACTOR AND SUBMITTED TO THE SEWER DISTRICT FOR REVIEW AFTER LATERAL CONNECTION HAS BEEN MADE OR THE MAIN REPAIRED. THE VIDEO INSPECTION SHALL BE PERFORMED IN ACCORDANCE WITH THE REQUIREMENTS DESCRIBED IN THE SPECIAL PROVISIONS FOR CLOSED CIRCUIT TELEVISION INSPECTION OF SANITARY SEWER MAINS (A COPY CAN BE OBTAINED FROM OUR WEBSITE AT [HTTP://PUBLICWORKS.SMCGOV.ORG/SEWER-SERVICE](http://PUBLICWORKS.SMCGOV.ORG/SEWER-SERVICE)). THE SEWER DISTRICT WILL REVIEW THE VIDEO INSPECTION TO DETERMINE WHETHER THE WORK PERFORMED IS ACCEPTABLE. ALL UNACCEPTABLE WORK SHALL BE CORRECTED TO THE SEWER DISTRICT'S SATISFACTION AT THE APPLICANT'S EXPENSE.
5. PRIVATE UTILITY LINES CROSSING SEWER DISTRICT MAINS SHALL HAVE A MINIMUM OF 12" VERTICAL CLEARANCE.
6. THE PROPERTY LINE CLEANOUT MUST BE PLACED IN A LOCATION THAT PROVIDES EASY ACCESS FOR MAINTENANCE EQUIPMENT AND IS OUTSIDE OF ANY ENCLOSURES. A MINIMUM OF 6' IS REQUIRED BETWEEN THE PROPERTY LINE CLEANOUT AND STRUCTURE.
7. IF THE LOWEST FINISHED FLOOR ELEVATION OF THE MAIN RESIDENCE OR SECOND UNIT WILL BE LESS THAN ONE (1) FOOT HIGHER THAN THE RIM ELEVATION OF THE NEAREST UPSTREAM SANITARY SEWER MANHOLE, A BACKFLOW PREVENTION OR OVERFLOW DEVICE MUST BE INSTALLED IMMEDIATELY UPSTREAM OF THE REQUIRED CLEANOUT NEAR THE PROPERTY LINE TO PREVENT BACKFLOW OF SEWAGE INTO THE BUILDING/PROPERTY.
8. SPOT REPAIR AT PROPERTY LINE CLEAN-OUT.
9. NEW CLEAN-OUT TO BE INSTALLED AT THE PROPERTY LINE.

HOUSE
FF = 33.02
PAD = 32.02

**VOL. 6 RSM PAGE 34
BLOCK 52
APN 060-083-360
LOT SIZE=6,598.31± SF**

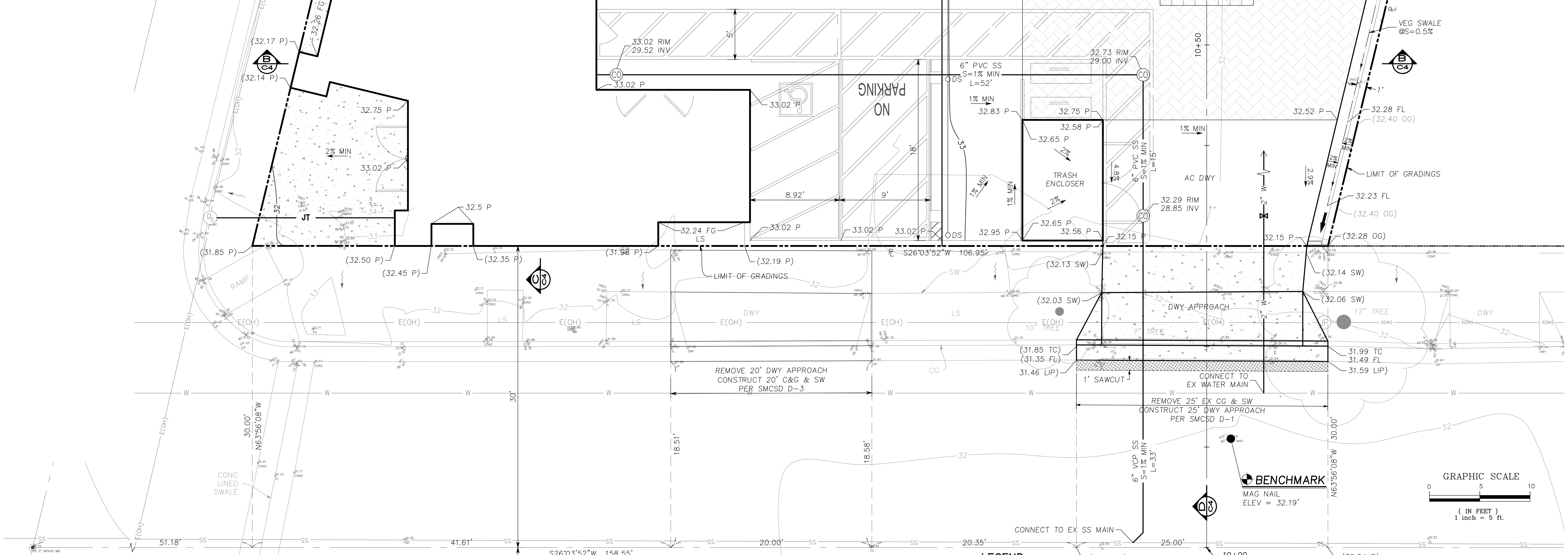

NOTES TO CONTRACTOR:

1. PRIOR TO THE COMMENCEMENT OF ANY WORK DONE IN THE PUBLIC RIGHT OF WAY A PERMIT TO OPEN STREET AND/OR ENCROACHMENT PERMIT WILL BE REQUIRED.
2. CONTRACTOR TO VERIFY LOCATIONS OF ALL EXISTING AND PROPOSED UTILITIES, STORM DRAIN, SANITARY SEWER BEFORE BEGIN WORK. CONTRACTOR TO NOTIFY ENGINEER IMMEDIATELY IF ANY DISCREPANCIES ARE FOUND IN FIELD.
3. GRADING WITHIN TREE DRIP LINES SHALL NOT BE PERFORMED UNLESS AUTHORIZED BY THE TOWN ARBORIST.
4. TRENCHING AND EXCAVATION FOR GRADING, DRAINAGE SWALES AND IRRIGATION LINES WITHIN THE TREE DRIP LINES SHALL BE DONE BY HAND OR USING AN AIRSPADE. WORKS WITHIN TREE DRIP LINES SHALL BE DONE UNDER THE SUPERVISOR OF THE PROJECT ARBORIST.

NOTES TO OWNER:

1. ALL PAVED AREAS SHALL BE KEPT CLEAR OF EARTH MATERIAL AND DEBRIS.
2. THE DRAINAGE SWALE SHALL BE MAINTAINED TO DIRECT FLOW AND RUNOFF TO DRYWELL.
3. REMOVE LEAVES AND TREE DEBRIS FROM FLOW PATHS AND ROOF GUTTERS.
4. REPAIR ANY DAMAGE TO GUTTERS OR DOWNSPOUTS.
5. JOINT TRENCH IS SHOWN FOR INTENT ONLY. FINAL LOCATION OF JOINT TRENCH SHALL BE DETERMINED BY PG&E.
6. ALL NEW UTILITIES SHALL BE PLACED UNDER GROUND.
7. ALL DAMAGED SECTIONS OF SIDEWALK AND ROADWAY MUST BE REMOVED AND REPLACED AS DIRECTED BY THE COUNTY INSPECTOR. NOTE THAT ADDITIONAL SLURRY SEAL WORK MAY BE REQUIRED IF WORK IS DONE WITHIN THE 2-YEAR MORATORIUM PERIOD AFTER COMPLETION OF MIDDLE ROAD IMPROVEMENT.

LEGEND:

- CONCRETE AREA
- ASPHALT CONCRETE AREA
- PERMEABLE CONCRETE PAVER AREA

NOTES:

1. DISTURBED AREA = 6,598 SQUARE FEET
2. PERMANENT GROUND COVER SHALL BE A COMBINATION OF GRASS, MULCH & GROUND COVER PLANTING.

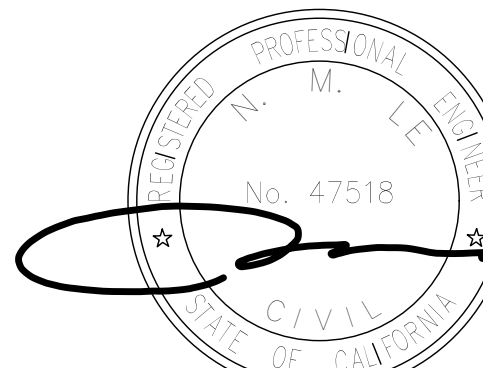

APPLICANT : NGUYEN

ROAD NAME : 3RD AVENUE

FILE NO :

DRAWING NO.	C3	
	SHEET NO.	3 OF 7
FILE NO.	PROJECT NO.	
<p>Redwood City California</p>		
<p>GRADING AND DRAINAGE PLAN 396 3RD AVENUE APN 060-083-360</p>		
<p>ENGINEERING 598 E Santa Clara St #270 San Jose, CA 95112 Phone: (408) 806-7187 Fax: (408) 583-4006</p>		
DATE	DATE	DATE
DESIGNED	PT	CHECKED
DATE	DATE	DATE
02/06/19	02/06/19	02/06/19
BY	DATE	REVISIONS
PT	BY	DATE
<p>PER COUNTY'S COMMENTS DATED 02/21/19</p>		
<p>NO.</p>		

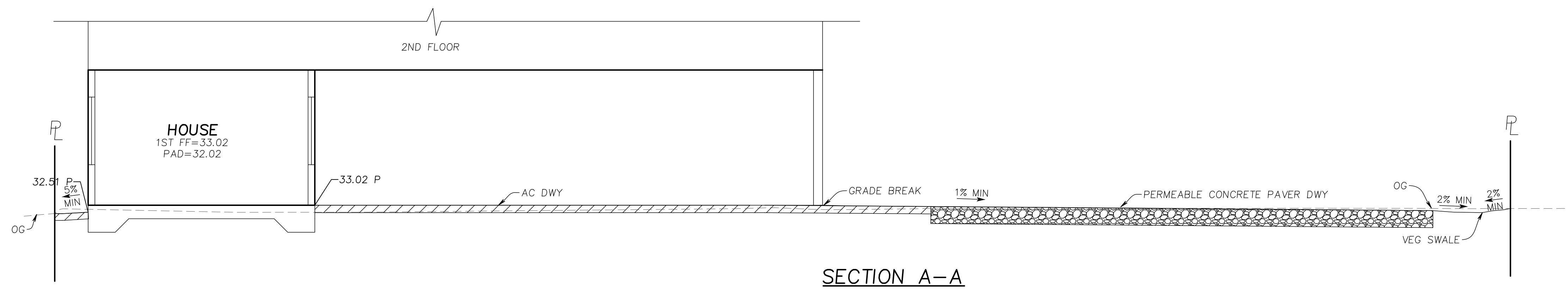

SECTION A-A

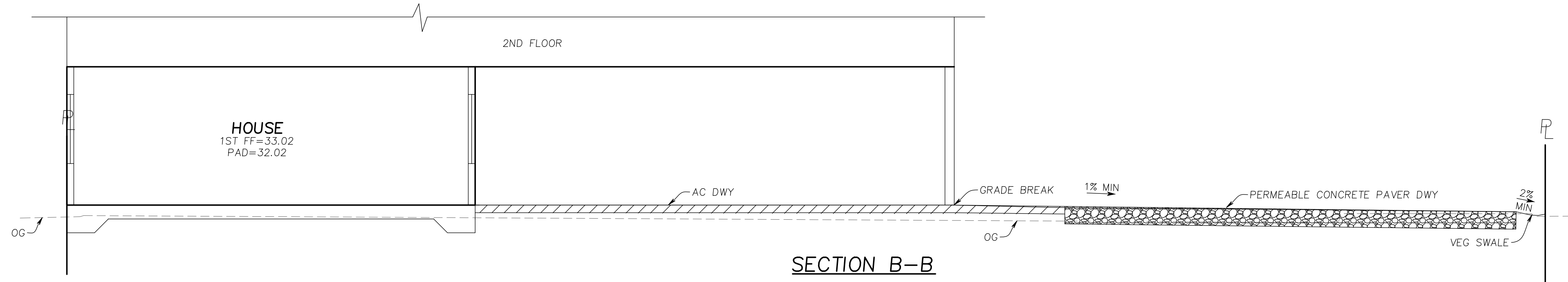

SECTION B-B

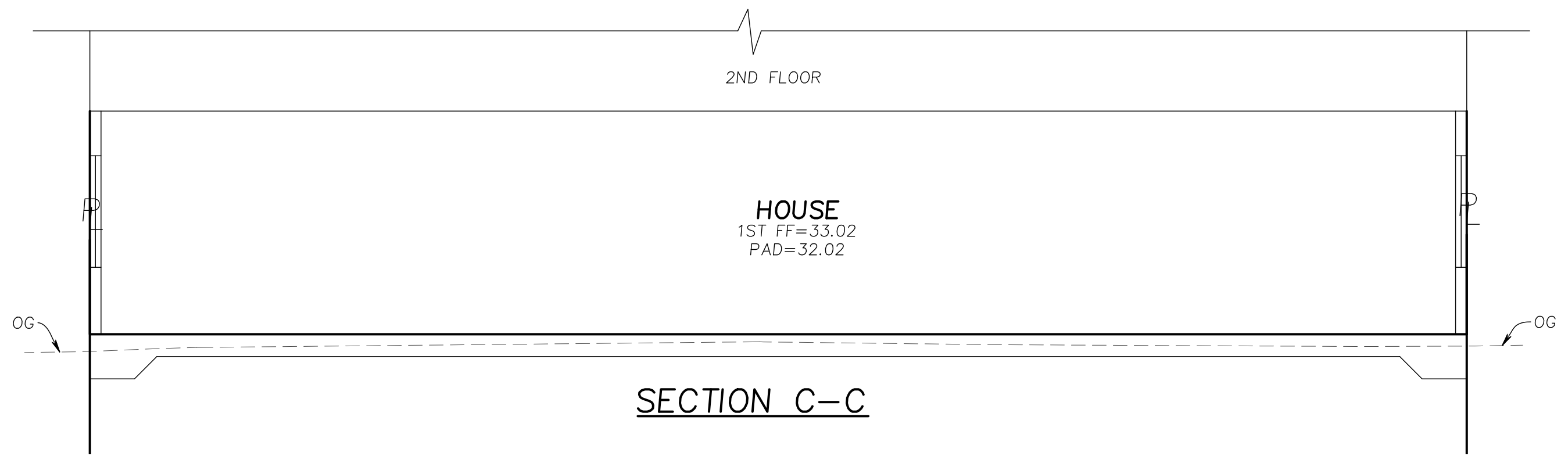

SECTION C-C

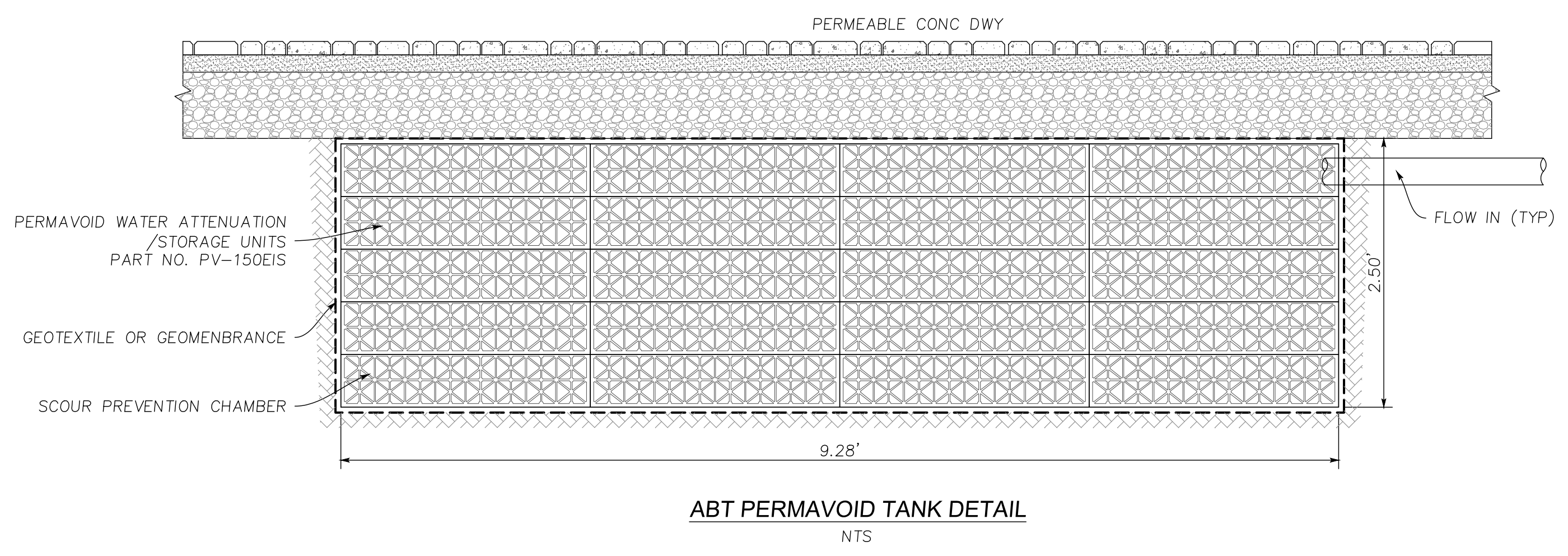

ABT PERMAVOID TANK DETAIL
NTS

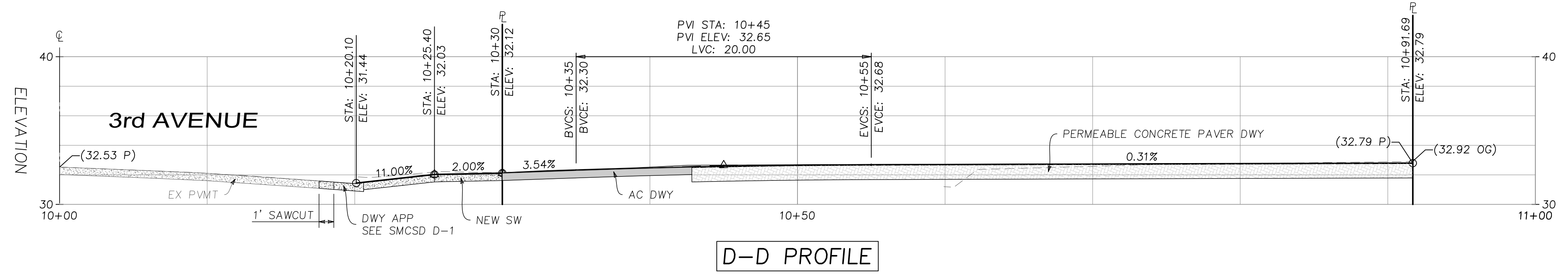

D-D PROFILE

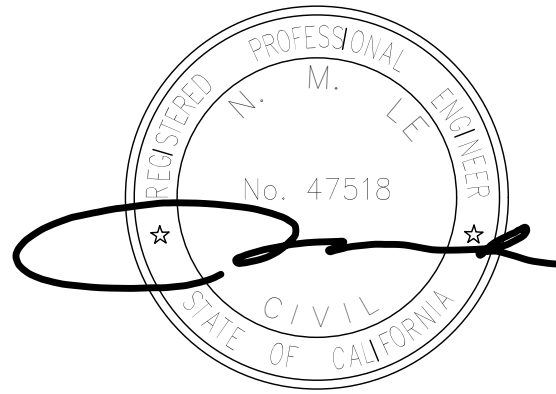
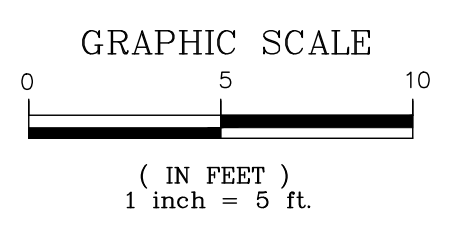

ENGINEERING 598 E Santa Clara St #270 San Jose, CA 95112 Phone: (408) 806-7187 Fax: (408) 583-4006	DESIGNED: 02/06/19 DATE: 02/06/19 DRAWN: 02/06/19 DATE: 02/06/19 SCALE: 1"=5' CHECKED: 02/06/19 DATE: 02/06/19
	PER COUNTY'S COMMENTS DATED 02/21/19 PT: 1 NO.
BUILDING CROSS SECTIONS 396 3RD AVENUE APN 060-083-360	PROJECT NO.
Redwood City CONTRACT NO.	California
DRAWING NO. C4 SHIT NO. 4 OF 7 FILE NO.	REVISIONS BY DATE APP'D NO.

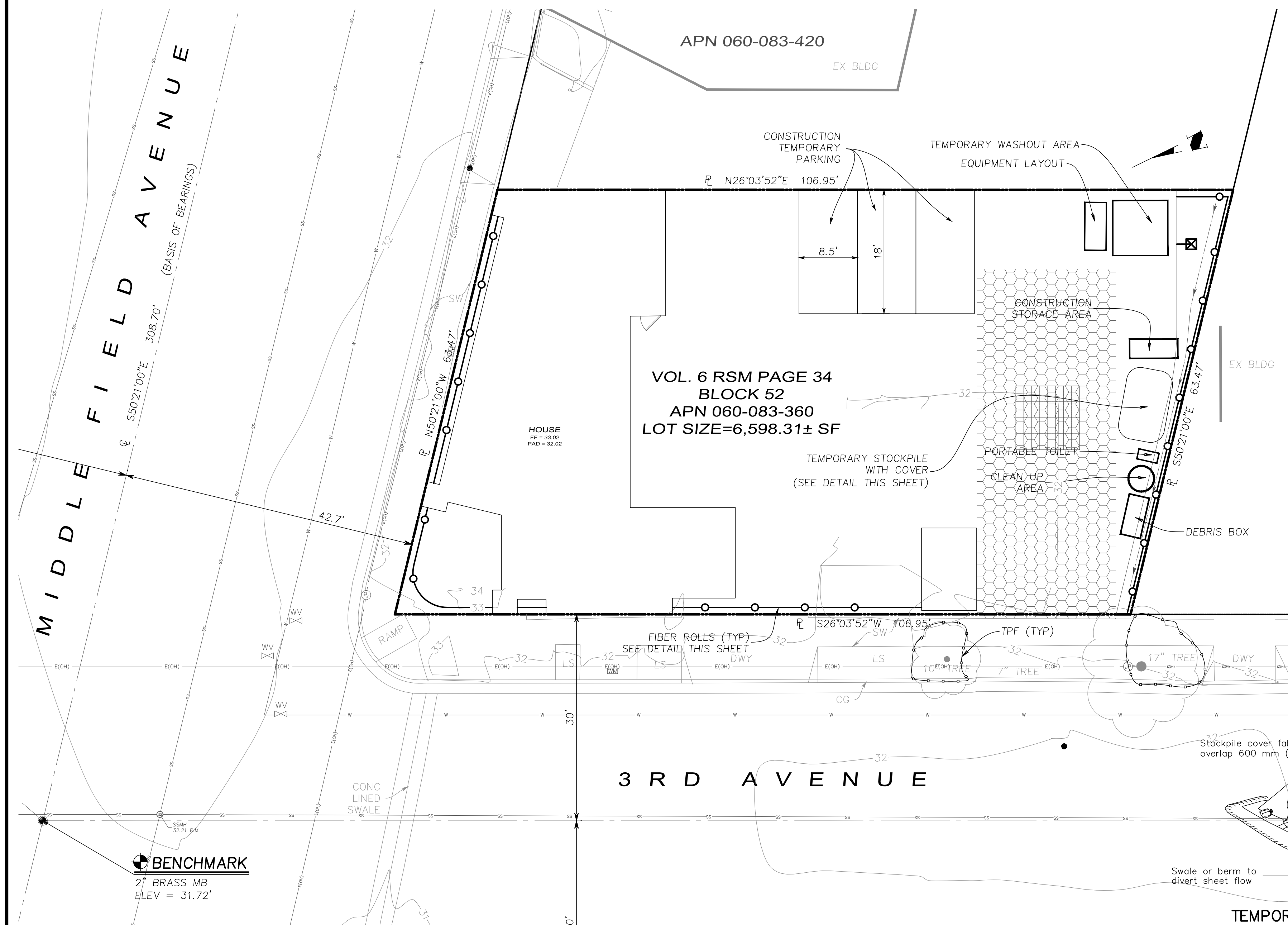

EROSION CONTROL NOTES

- THIS PLAN IS INTENDED TO BE USED FOR INTERIM EROSION AND SEDIMENT CONTROL ONLY AND IS NOT TO BE USED FOR FINAL PLAN ELEVATIONS OR PERMANENT IMPROVEMENTS. THE COUNTY INSPECTOR MAY REQUIRE INSTALLING ADDITIONAL EROSION CONTROL MEASURES DURING EARTHWORK OPERATION.
- OWNER/CONTRACTOR SHALL BE RESPONSIBLE FOR MONITORING EROSION AND SEDIMENT CONTROL MEASURES PRIOR, DURING, AND AFTER STORM EVENTS.
- REASONABLE CARE SHALL BE TAKEN WHEN HAULING ANY EARTH, SAND, GRAVEL, STONE, DEBRIS, PAPER OR ANY OTHER SUBSTANCE OVER ANY PUBLIC STREET, ALLEY OR OTHER PUBLIC PLACE. SHOULD ANY BLOW, SPILL, OR TRACK OVER AND UPON SAID PUBLIC OR ADJACENT PRIVATE PROPERTY, IMMEDIATE REMEDY SHALL OCCUR.
- DURING THE RAINY SEASON, ALL PAVED AREAS SHALL BE KEPT CLEAR OF EARTH MATERIAL AND DEBRIS. THE SITE SHALL BE MAINTAINED SO AS TO MINIMIZE SEDIMENT LADEN RUNOFF TO ANY STORM DRAINAGE SYSTEM, INCLUDING EXISTING DRAINAGE SWALES AND WATER COURSES.
- CONTRACTOR SHALL PROVIDE DUST CONTROL AS REQUIRED BY THE APPROPRIATE FEDERAL, STATE AND LOCAL AGENCY.
- THE FACILITIES SHOWN ON THIS PLAN ARE DESIGNED TO CONTROL EROSION AND SEDIMENT DURING THE RAINY SEASON, OCTOBER 15 TO APRIL 15. GRADING OPERATIONS DURING THE RAINY SEASON WHICH LEAVE DENUDE SLOPES SHALL BE PROTECTED WITH EROSION CONTROL MEASURES IMMEDIATELY FOLLOWING GRADING ON THE SLOPES. GRADING WORK BETWEEN OCTOBER 15 TO APRIL 15 IS AT THE DISCRETION OF THE COUNTY OF SAN MATEO BUILDING OFFICIAL.
- FINISHED SLOPES ON THE SITE SHALL BE STABILIZED USING SEED AND STRAW OR HYDROSEED TREATMENTS.
- ACTIVE DRAINAGE INLETS AND NATURAL DRAINAGES WHERE RUNOFF IS LIKELY TO GO SHALL HAVE DRAINAGE INLET PROTECTION INSTALLED AROUND THE IMMEDIATE PERIMETER OF THE INLET AS NOTED ON THE PLANS.
- UNFINISHED ROADWAY AREAS SHALL BE PROTECTED FROM EROSION AS SHOWN ON THE EROSION CONTROL PLAN. HAY BALE CHECK DAMS WILL BE REQUIRED ON ROADWAY SLOPES STEEPER THAN FIVE PERCENT.
- IF THE APPROVED EROSION CONTROL PLAN DOES NOT WORK, THE COUNTY OF SAN MATEO CONSTRUCTION INSPECTOR CAN CHANGE THE EROSION CONTROL MEASURES AND LAYOUT.

GRADING AND OPERATION NOTES

- CONSTRUCTION TRAILER, IF PROPOSED, SHALL BE LOCATED OUTSIDE OF SETBACK LINES AS SHOWN ON THE PLAN.
- ALL CONSTRUCTION PARKING SHALL BE LOCATED ON SITE.
- EXISTING DRIVEWAY SHALL BE MAINTAINED DURING CONSTRUCTION FOR INGRESS AND EGRESS.
- DEBRIS BOX AND TEMPORARY TOILET SHALL BE LOCATED AS SHOWN ON THE PLAN. CONTRACTOR MAY RELOCATE THE DEBRIS BOX AND TEMPORARY TOILET UPON RECEIVING APPROVAL FROM THE COUNTY OF SAN MATEO.
- RUN OFF FROM THE DESIGNATED CLEAN UP AREA SHALL BE CONTAINED BY PROVIDING TEMPORARY BASE OF WOOD CHIPS OR OTHER NATURAL ABSORBENT MATERIAL TO BE DISPOSED OFF SITE.
- RUN OFF FROM THE DESIGNATED CLEAN UP AREA SHALL BE CONTAINED BY PROVIDING TEMPORARY BASE OF WOOD CHIPS OR OTHER NATURAL ABSORBENT MATERIAL TO BE DISPOSED OFF SITE.
- CONTRACTOR SHALL STORE CONSTRUCTION MATERIALS WITHIN THE DESIGNATED STORAGE AREA AS SHOWN ON THE PLAN.
- WATER SHALL BE AVAILABLE ON SITE FOR DUST CONTROL DURING GRADING OPERATIONS.
- WORK HOURS - MONDAY THROUGH SATURDAY FROM 8:00 AM TO 5:30 PM. NO HAULING OR HEAVY EQUIPMENT PERMITTED ON SATURDAYS. NO WORK PERMITTED ON SUNDAYS AND HOLIDAYS.
- CONTRACTOR SHALL STORE CONSTRUCTION MATERIALS WITHIN THE DESIGNATED STORAGE AREA AS SHOWN ON THE PLAN.
- ARRANGEMENT MUST BE MADE WITH THE GREEN WASTE RECOVERY, INC. (650-947-4994) FOR THE DEBRIS BOX. NO OTHER HAULER IS ALLOWED WITHIN THE CITY/COUNTY LIMITS.
- CONSTRUCTION, OPERATION AND MAINTENANCE OF EROSION AND SEDIMENT CONTROLS, INCLUDE INSPECTION FREQUENCY
- METHODS AND SCHEDULE FOR GRADING, EXCAVATION, FILLING, CLEARING OF VEGETATION, AND STORAGE AND DISPOSAL OF EXCAVATED OR CLEARED MATERIAL.
- SPECIFICATIONS FOR VEGETATIVE COVER & MULCH, INCLUDE METHODS AND SCHEDULES FOR PLANTING AND FERTILIZATION.
- PROVISIONS FOR TEMPORARY AND/OR PERMANENT IRRIGATION.

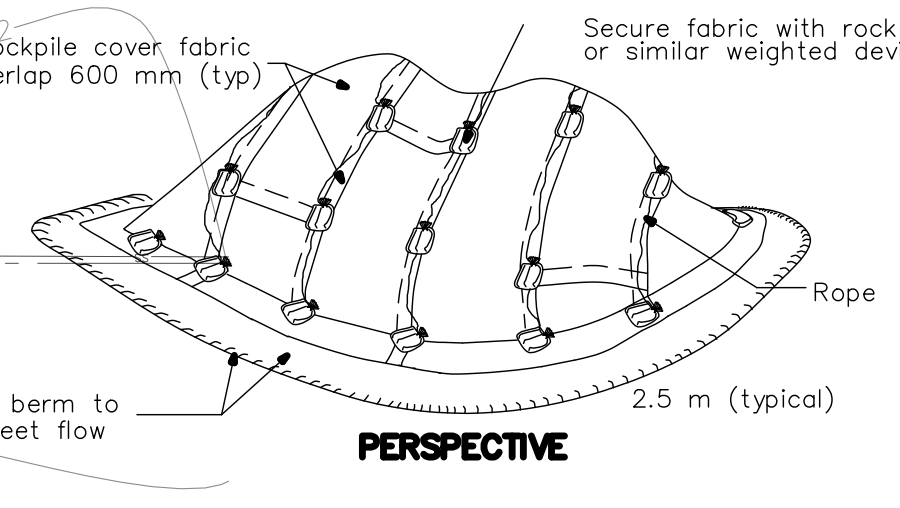

TEMPORARY COVER ON STOCKPILE

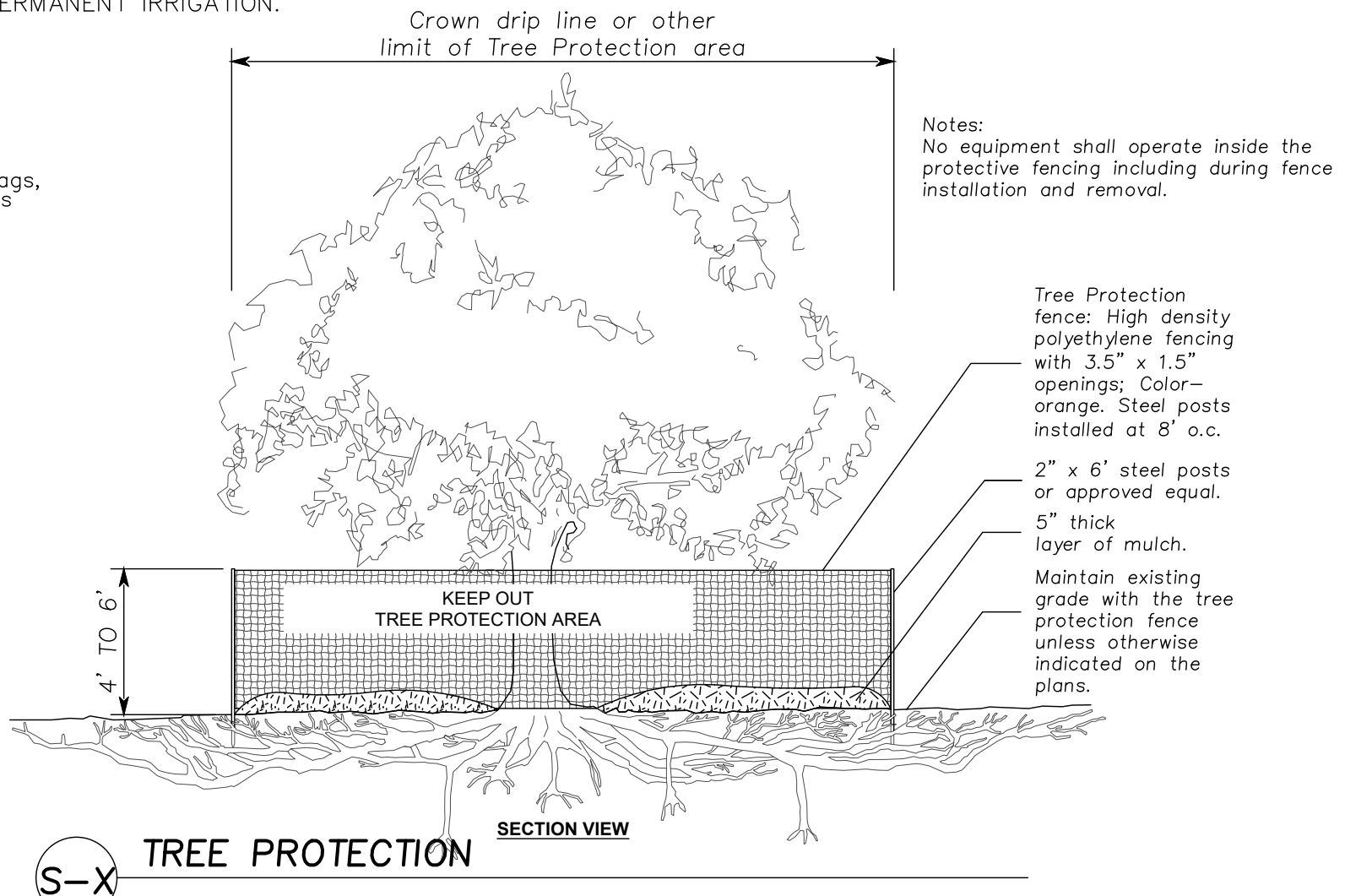

TREE PROTECTION SECTION VIEW

Storm Drain Inlet Protection

SC-10

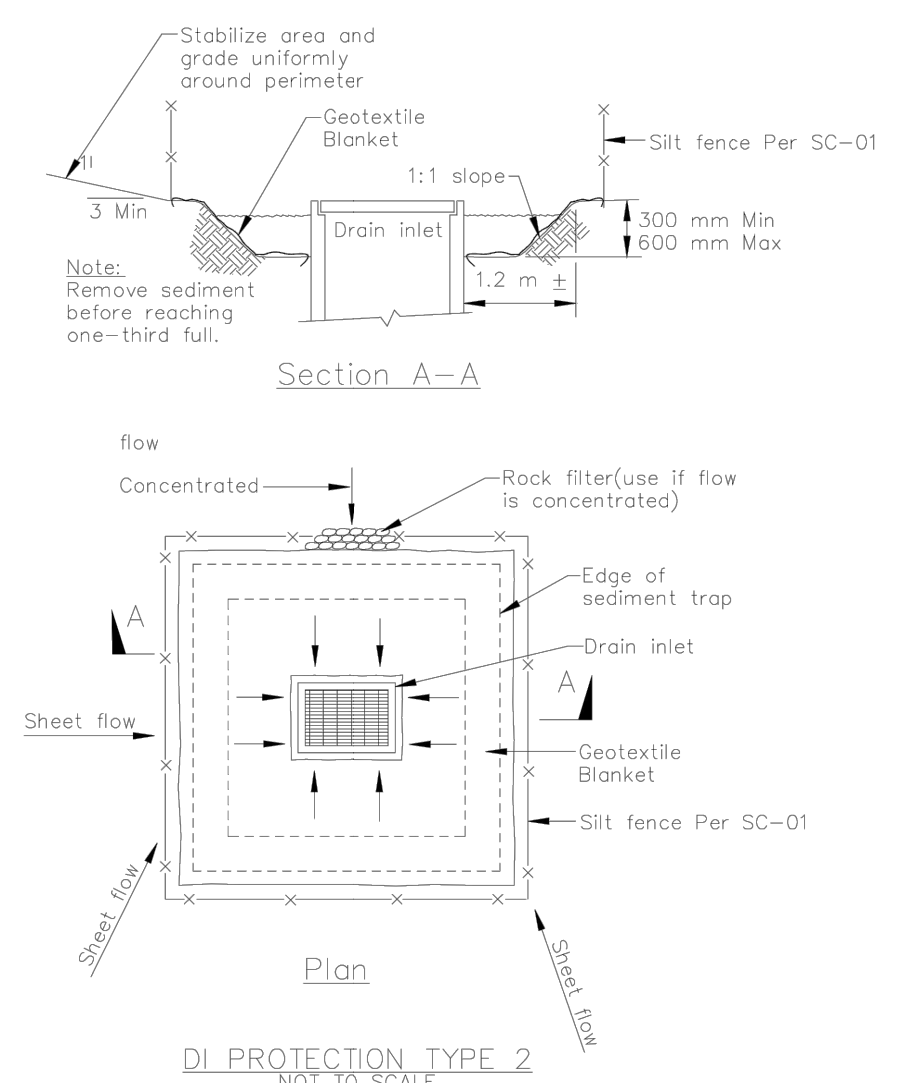

Notes:
 1. For use in cleared and grubbed and in graded areas.
 2. Shape basin so that longest inflow area faces longest length of trap.
 3. For concentrated flows, shape basin in 2:1 ratio with length oriented towards direction of flow.

Stabilized Construction Entrance/Exit

TC-1

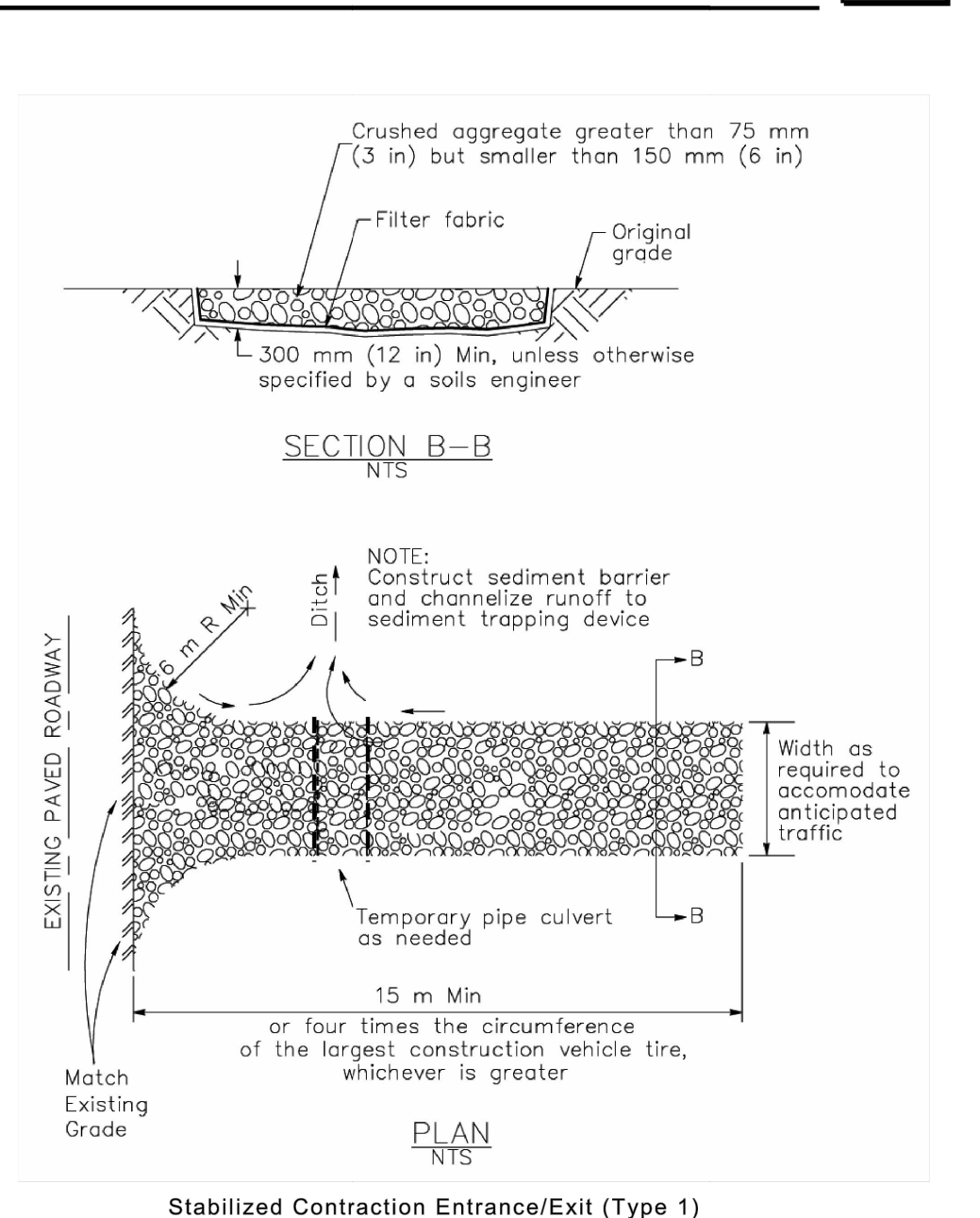

Stabilized Construction Entrance/Exit (Type 1)

Fiber Rolls

SC-5

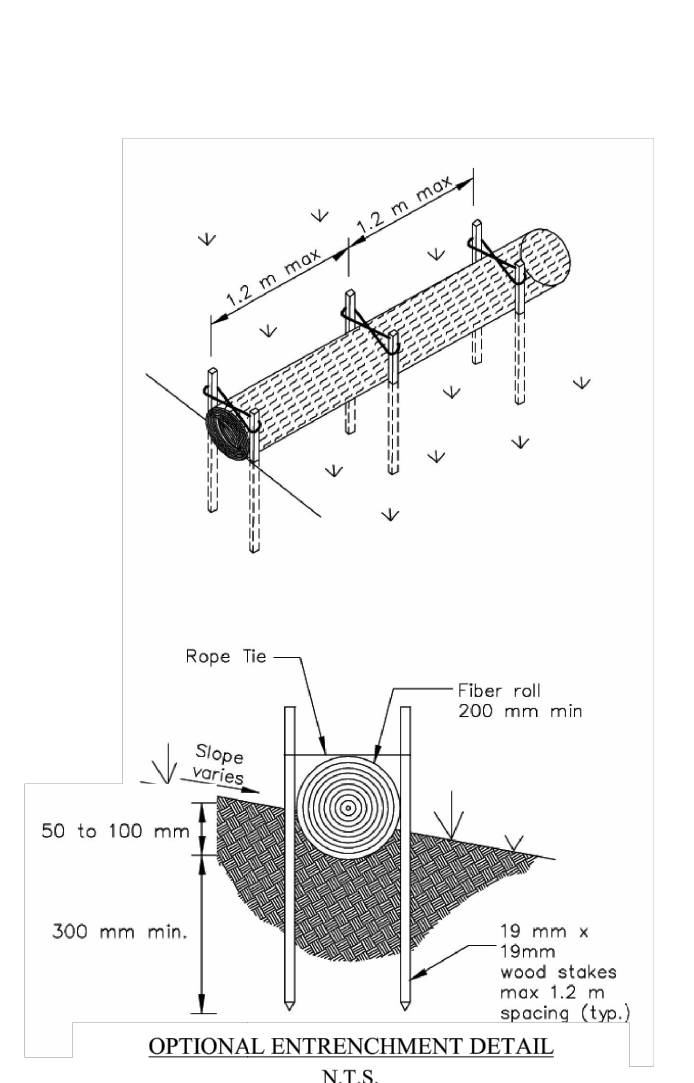

OPTIONAL ENTRENCHMENT DETAIL N.T.S.

TREE PROTECTION:

TREE PROTECTION FENCING
 TREE PROTECTION ZONES SHOULD BE ESTABLISHED AND MAINTAINED THROUGHOUT THE ENTIRE LENGTH OF THE PROJECT. FENCING FOR THE PROTECTION ZONES SHOULD BE 6 FOOT TALL METAL CHAIN LINK TYPE FENCING SUPPORTED BY METAL POLES POUNDED INTO THE GROUND. THE SUPPORT POLES SHOULD BE SPACED NO MORE THAN 10 FEET APART ON CENTER. THE LOCATION FOR THE PROTECTION FENCING SHOULD BE AS CLOSE TO THE DRIPLINE AS POSSIBLE STILL ALLOWING ROOM FOR CONSTRUCTION TO SAFELY CONTINUE. SIGNS SHOULD BE PLACED ON FENCING SIGNIFYING "TREE PROTECTION ZONE - KEEP OUT". NO MATERIALS OR EQUIPMENT SHOULD BE STORED OR CLEANED INSIDE THE TREE PROTECTION ZONES.
 ALL TREE PROTECTION MUST BE IN PLACE PRIOR TO THE START OF ANY DEMOLITION. DEMOLITION EQUIPMENT WILL ACCESS THE PROPERTY FROM THE EXISTING DRIVEWAY. IF DEMOLITION EQUIPMENT IS TO STRAY OFF THE EXISTING DRIVEWAY 6 INCHES OF CHIPS COVERED WITH STEEL PLATES OR PLYWOOD WILL BE INSTALLED BENEATH PROTECTED TREES DRIPLINES.

TRENCHING
 TRENCHING FOR IRRIGATION, ELECTRICAL, DRAINAGE OR ANY OTHER REASON SHOULD BE HAND DUG WHEN BENEATH THE DRIPLINES OF PROTECTED TREES. HAND DIGGING AND CAREFULLY LAYING PIPES BELOW OR BESIDE PROTECTED ROOTS WILL DRAMATICALLY REDUCE ROOT LOSS OF DESIRED TREES THUS REDUCING TRAUMA TO THE ENTIRE TREE. TRENCHES SHOULD BE BACKFILLED AS SOON AS POSSIBLE WITH NATIVE MATERIAL AND COMPACTED TO NEAR ITS ORIGINAL LEVEL. TRENCHES THAT MUST BE LEFT EXPOSED FOR A PERIOD OF TIME SHOULD ALSO BE COVERED WITH LAYERS OF BURLAP OR STRAW WATTLE AND KEPT MOIST. PLYWOOD OVER THE TOP OF THE TRENCH WILL ALSO HELP PROTECT EXPOSED ROOTS BELOW.

IRRIGATION
 NORMAL IRRIGATION SHOULD BE MAINTAINED THROUGHOUT THE ENTIRE LENGTH OF THE PROJECT. THE IMPORTED TREES WILL REQUIRE REGULAR IRRIGATION. THE NATIVE OAKS SHOULD NOT REQUIRE WARM SEASON IRRIGATION UNLESS THEIR ROOT ZONES ARE TRAUMATIZED. IF ROOT DAMAGE WERE TO OCCUR SOME IRRIGATION MAY BE REQUIRED DURING THE WINTER MONTHS DEPENDING ON THE SEASONAL RAINFALL. DURING THE SUMMER MONTHS THE TREES ON THIS SITE SHOULD RECEIVE HEAVY FLOOD TYPE IRRIGATION 2 TIMES A MONTH. DURING THE FALL AND WINTER 1 TIME A MONTH SHOULD SUFFICE. MULCHING THE ROOT ZONE OF PROTECTED TREES WILL HELP THE SOIL RETAIN MOISTURE, THUS REDUCING WATER CONSUMPTION. THE NATIVE OAKS SHOULD NOT REQUIRE IRRIGATION UNLESS THEIR DRIPLINES HAVE BEEN TRAUMATIZED.

TREE TRIMMING
 THE TRIMMING OF PROTECTED TREES ON THIS SITE TO FACILITATE CONSTRUCTION WILL BE MINOR. ALL TRIMMING WILL BE CARRIED OUT BY A LICENSED CONTRACTOR AND INSPECTED BY THE SITE ARBORIST.

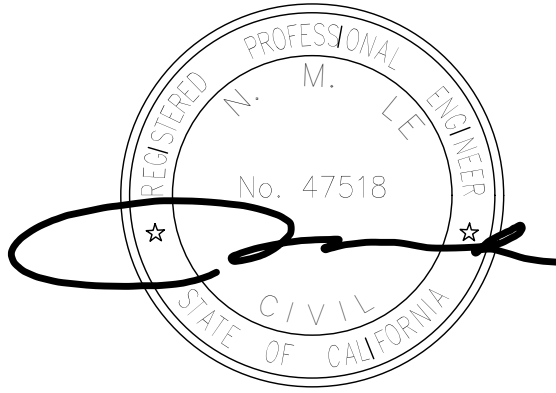
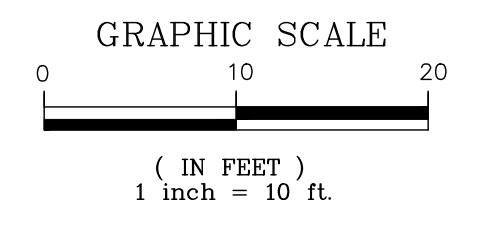

DRAWING NO.	C5	
	SHEET NO.	5 OF 7
FILE NO.	PROJECT NO.	
EROSION CONTROL PLAN AND CONSTRUCTION OPERATION PLAN 396 3RD AVENUE APN 060-083-360		
ENGINEERING 598 E Santa Clara St #270 San Jose, CA 95112 Phone: (408) 806-7187 Fax: (408) 583-4006		
Redwood City CONTRACT NO.		
PER COUNTY'S COMMENTS DATED 02/21/19		
DESIGNED	DATE	02/06/19
PT	DATE	02/06/19
DRAWN	DATE	
SCALE	SCALE	1"=10'
CHECKED	DATE	02/06/19
BY	DATE	
REVISIONS	DATE	
NO.	DATE	



SAN MATEO COUNTYWIDE
**Water Pollution
Prevention Program**
Clean Water. Healthy Community.

Construction Best Management Practices (BMPs)

Construction projects are required to implement the stormwater best management practices (BMP) on this page, as they apply to your project, all year long.

Materials & Waste Management

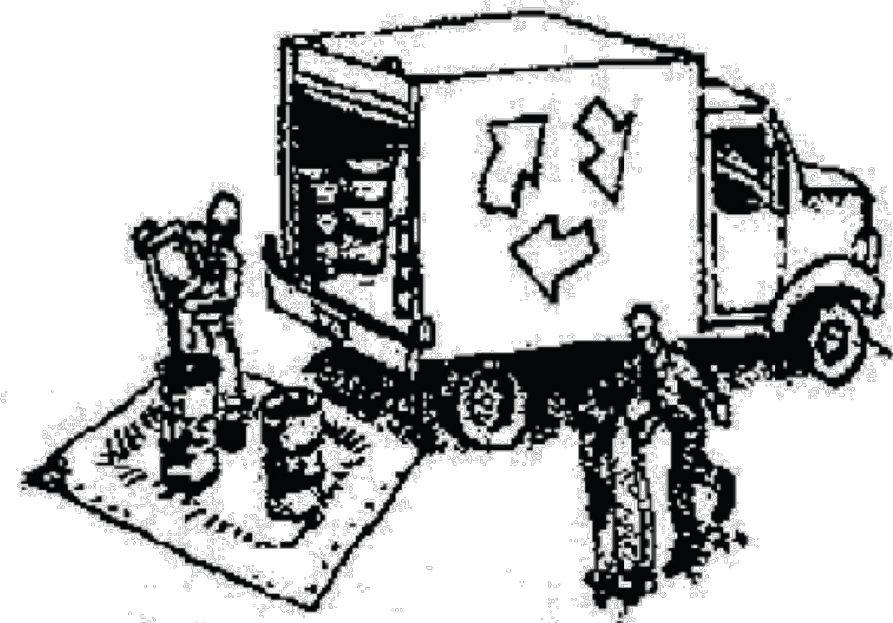

Non-Hazardous Materials

- Berm and cover stockpiles of sand, dirt or other construction material with tarps when rain is forecast or if not actively being used within 14 days.
- Use (but don't overuse) reclaimed water for dust control.

Hazardous Materials

- Label all hazardous materials and hazardous wastes (such as pesticides, paints, thinners, solvents, fuel, oil, and antifreeze) in accordance with city, county, state and federal regulations.
- Store hazardous materials and wastes in water tight containers, store in appropriate secondary containment, and cover them at the end of every work day or during wet weather or when rain is forecast.
- Follow manufacturer's application instructions for hazardous materials and be careful not to use more than necessary. Do not apply chemicals outdoors when rain is forecast within 24 hours.
- Arrange for appropriate disposal of all hazardous wastes.

Waste Management

- Cover waste disposal containers securely with tarps at the end of every work day and during wet weather.
- Check waste disposal containers frequently for leaks and to make sure they are not overfilled. Never hose down a dumpster on the construction site.
- Clean or replace portable toilets, and inspect them frequently for leaks and spills.
- Dispose of all wastes and debris properly. Recycle materials and wastes that can be recycled (such as asphalt, concrete, aggregate base materials, wood, gyp board, pipe, etc.)
- Dispose of liquid residues from paints, thinners, solvents, glues, and cleaning fluids as hazardous waste.

Construction Entrances and Perimeter

- Establish and maintain effective perimeter controls and stabilize all construction entrances and exits to sufficiently control erosion and sediment discharges from site and tracking off site.
- Sweep or vacuum any street tracking immediately and secure sediment source to prevent further tracking. Never hose down streets to clean up tracking.

Equipment Management & Spill Control



Maintenance and Parking

- Designate an area, fitted with appropriate BMPs, for vehicle and equipment parking and storage.
- Perform major maintenance, repair jobs, and vehicle and equipment washing off site.
- If refueling or vehicle maintenance must be done onsite, work in a bermed area away from storm drains and over a drip pan or drop cloths big enough to collect fluids. Recycle or dispose of fluids as hazardous waste.
- If vehicle or equipment cleaning must be done onsite, clean with water only in a bermed area that will not allow rinse water to run into gutters, streets, storm drains, or surface waters.
- Do not clean vehicle or equipment onsite using soaps, solvents, degreasers, or steam cleaning equipment.

Spill Prevention and Control

- Keep spill cleanup materials (e.g., rags, absorbents and cat litter) available at the construction site at all times.
- Inspect vehicles and equipment frequently for and repair leaks promptly. Use drip pans to catch leaks until repairs are made.
- Clean up spills or leaks immediately and dispose of cleanup materials properly.
- Do not hose down surfaces where fluids have spilled. Use dry cleanup methods (absorbent materials, cat litter, and/or rags).
- Sweep up spilled dry materials immediately. Do not try to wash them away with water, or bury them.
- Clean up spills on dirt areas by digging up and properly disposing of contaminated soil.
- Report significant spills immediately. You are required by law to report all significant releases of hazardous materials, including oil. To report a spill: 1) Dial 911 or your local emergency response number, 2) Call the Governor's Office of Emergency Services Warning Center, (800) 852-7550 (24 hours).

Earthmoving

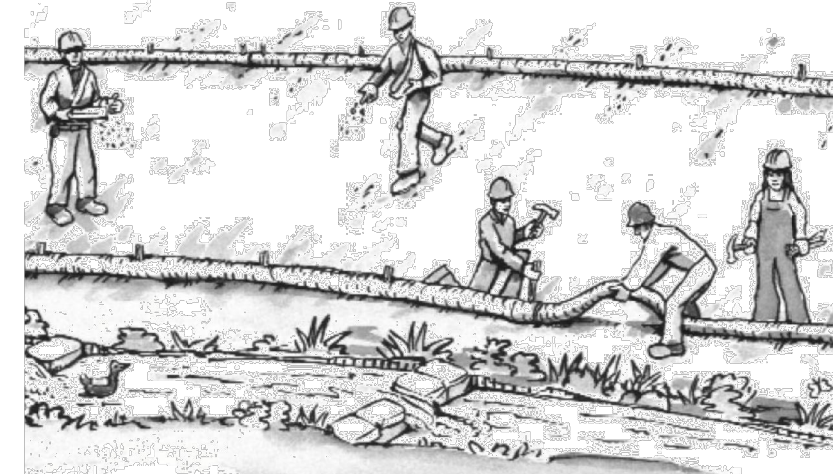

- Schedule grading and excavation work during dry weather.
- Stabilize all denuded areas, install and maintain temporary erosion controls (such as erosion control fabric or bonded fiber matrix) until vegetation is established.
- Remove existing vegetation only when absolutely necessary, and seed or plant vegetation for erosion control on slopes or where construction is not immediately planned.
- Prevent sediment from migrating offsite and protect storm drain inlets, gutters, ditches, and drainage courses by installing and maintaining appropriate BMPs, such as fiber rolls, silt fences, sediment basins, gravel bags, berms, etc.
- Keep excavated soil on site and transfer it to dump trucks on site, not in the streets.

Contaminated Soils

- If any of the following conditions are observed, test for contamination and contact the Regional Water Quality Control Board:
 - Unusual soil conditions, discoloration, or odor.
 - Abandoned underground tanks.
 - Abandoned wells
 - Buried barrels, debris, or trash.

Paving/Asphalt Work

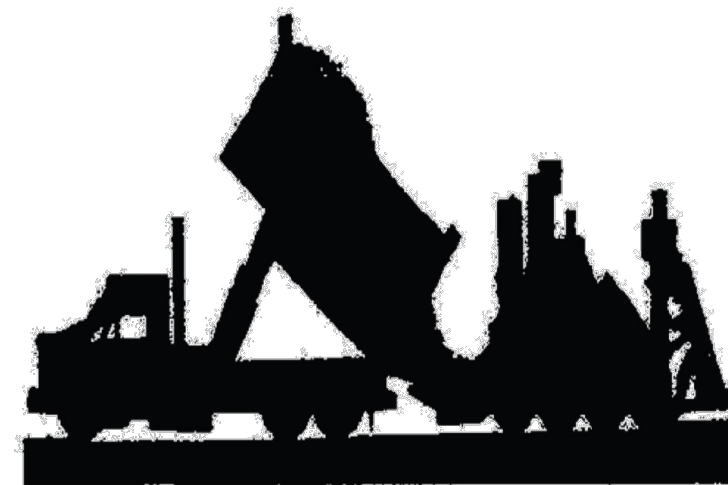

- Avoid paving and seal coating in wet weather or when rain is forecast, to prevent materials that have not cured from contacting stormwater runoff.
- Cover storm drain inlets and manholes when applying seal coat, tack coat, slurry seal, fog seal, etc.
- Collect and recycle or appropriately dispose of excess abrasive gravel or sand. Do NOT sweep or wash it into gutters.
- Do not use water to wash down fresh asphalt concrete pavement.

Sawcutting & Asphalt/Concrete Removal

- Protect nearby storm drain inlets when saw cutting. Use filter fabric, catch basin inlet filters, or gravel bags to keep slurry out of the storm drain system.
- Shovel, absorb, or vacuum saw-cut slurry and dispose of all waste as soon as you are finished in one location or at the end of each work day (whichever is sooner!).
- If sawcut slurry enters a catch basin, clean it up immediately.

Concrete, Grout & Mortar Application

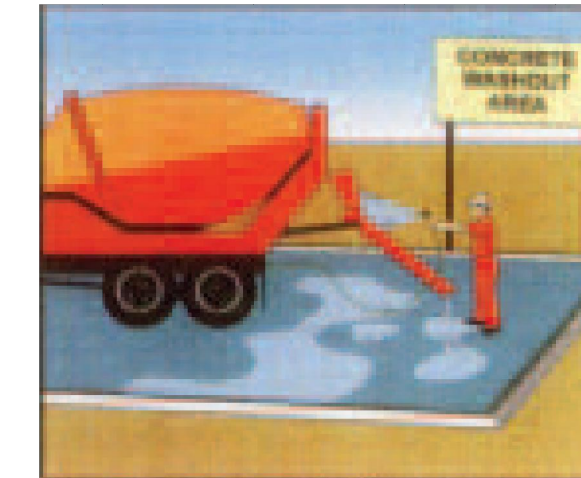

- Store concrete, grout, and mortar away from storm drains or waterways, and on pallets under cover to protect them from rain, runoff, and wind.
- Wash out concrete equipment/trucks offsite or in a designated washout area, where the water will flow into a temporary waste pit, and in a manner that will prevent leaching into the underlying soil or onto surrounding areas. Let concrete harden and dispose of as garbage.
- When washing exposed aggregate, prevent washwater from entering storm drains. Block any inlets and vacuum gutters, hose washwater onto dirt areas, or drain onto a bermed surface to be pumped and disposed of properly.

Landscaping

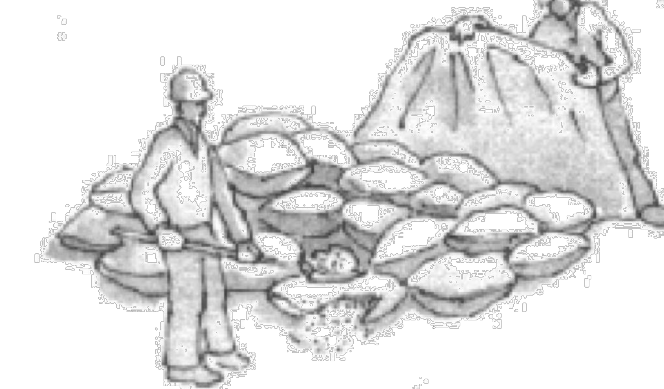

- Protect stockpiled landscaping materials from wind and rain by storing them under tarps all year-round.
- Stack bagged material on pallets and under cover.
- Discontinue application of any erodible landscape material within 2 days before a forecast rain event or during wet weather.

Painting & Paint Removal

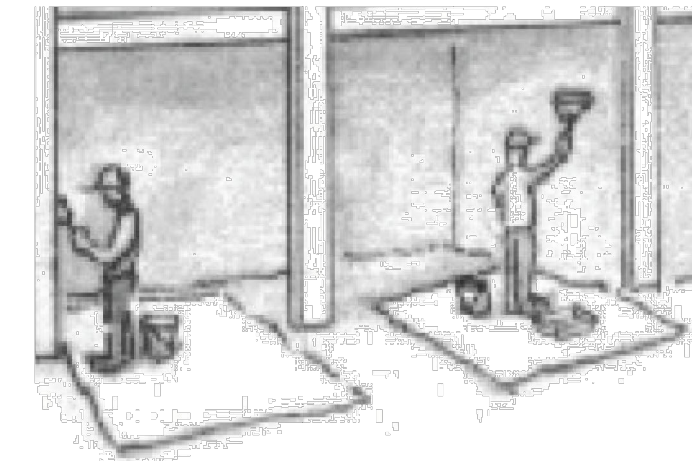

Painting Cleanup and Removal

- Never clean brushes or rinse paint containers into a street, gutter, storm drain, or stream.
- For water-based paints, paint out brushes to the extent possible, and rinse into a drain that goes to the sanitary sewer. Never pour paint down a storm drain.
- For oil-based paints, paint out brushes to the extent possible and clean with thinner or solvent in a proper container. Filter and reuse thinners and solvents. Dispose of excess liquids as hazardous waste.
- Paint chips and dust from non-hazardous dry stripping and sand blasting may be swept up or collected in plastic drop cloths and disposed of as trash.
- Chemical paint stripping residue and chips and dust from marine paints or paints containing lead, mercury, or tributyltin must be disposed of as hazardous waste. Lead based paint removal requires a state-certified contractor.

Dewatering

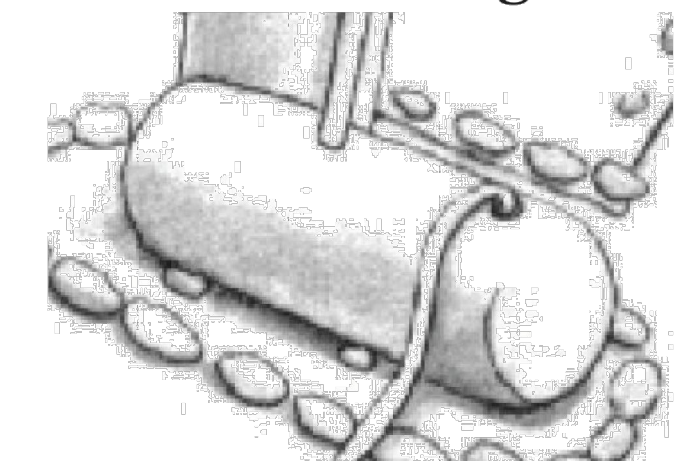

- Discharges of groundwater or captured runoff from dewatering operations must be properly managed and disposed. When possible send dewatering discharge to landscaped area or sanitary sewer. If discharging to the sanitary sewer call your local wastewater treatment plant.
- Divert run-on water from offsite away from all disturbed areas.
- When dewatering, notify and obtain approval from the local municipality before discharging water to a street gutter or storm drain. Filtration or diversion through a basin, tank, or sediment trap may be required.
- In areas of known or suspected contamination, call your local agency to determine whether the ground water must be tested. Pumped groundwater may need to be collected and hauled off-site for treatment and proper disposal.

Storm drain polluters may be liable for fines of up to \$10,000 per day!

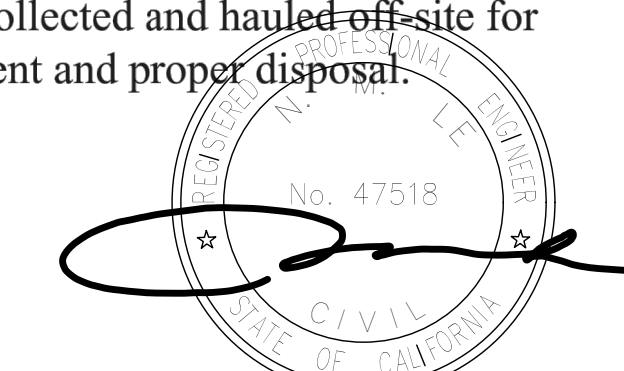

PER COUNTY'S COMMENTS DATED 02/21/19		PT	DATE	BY	DATE	REVISIONS	NO.
DESIGNED	DATE	DRAWN	DATE	CHECKED	DATE		
PT	02/06/19		02/06/19		02/06/19		
BLUE PRINT FOR A CLEAN BAY 396 3RD AVENUE APN 060-083-360							
ENGINEERING 598 E Santa Clara St #270 San Jose, CA 95112 Phone: (408) 806-7187 Fax: (408) 583-4006				California PROJECT NO.			
DRAWING NO. C6				CONTRACT NO.			
SHT NO. 6 OF 7				FILE NO.			

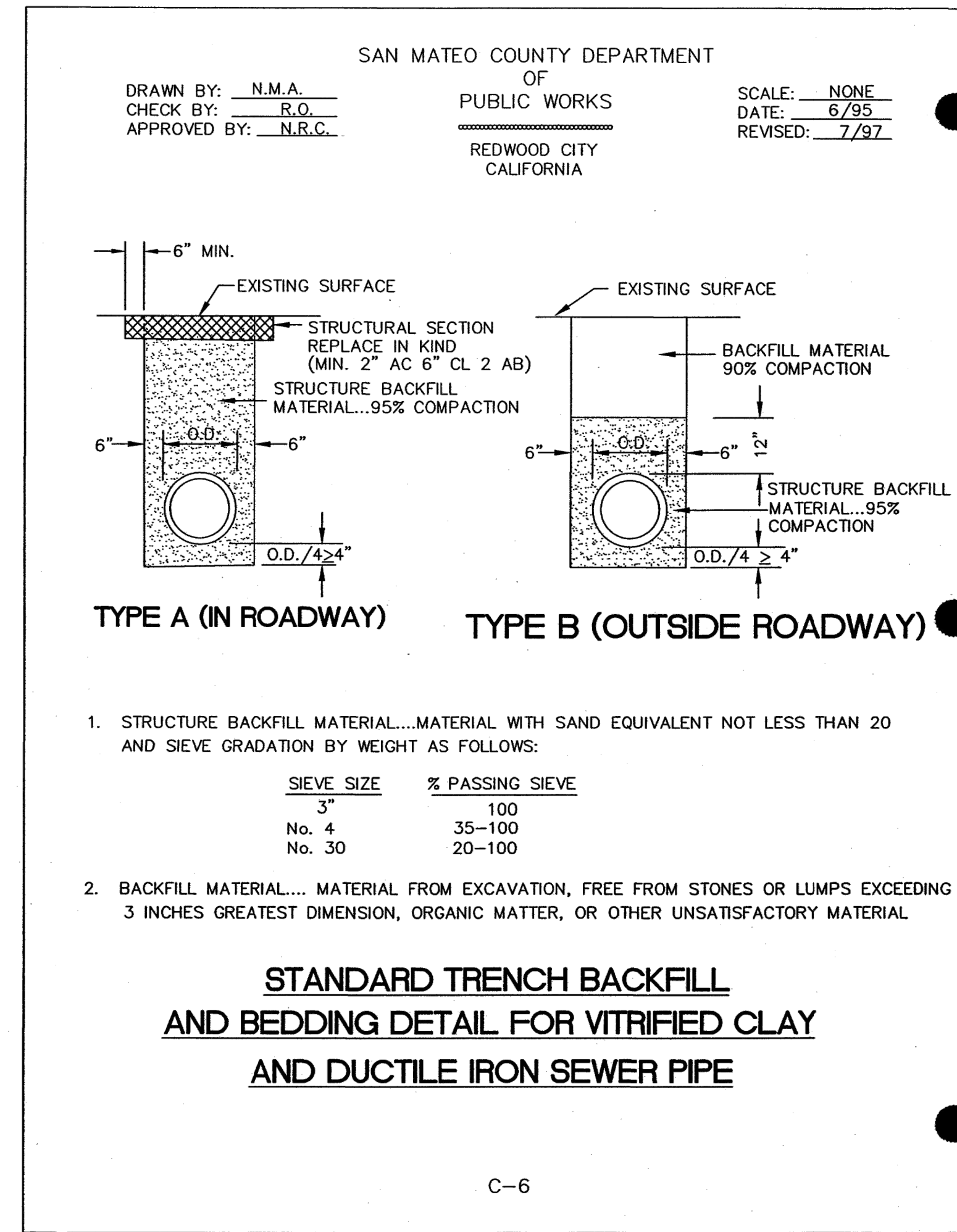
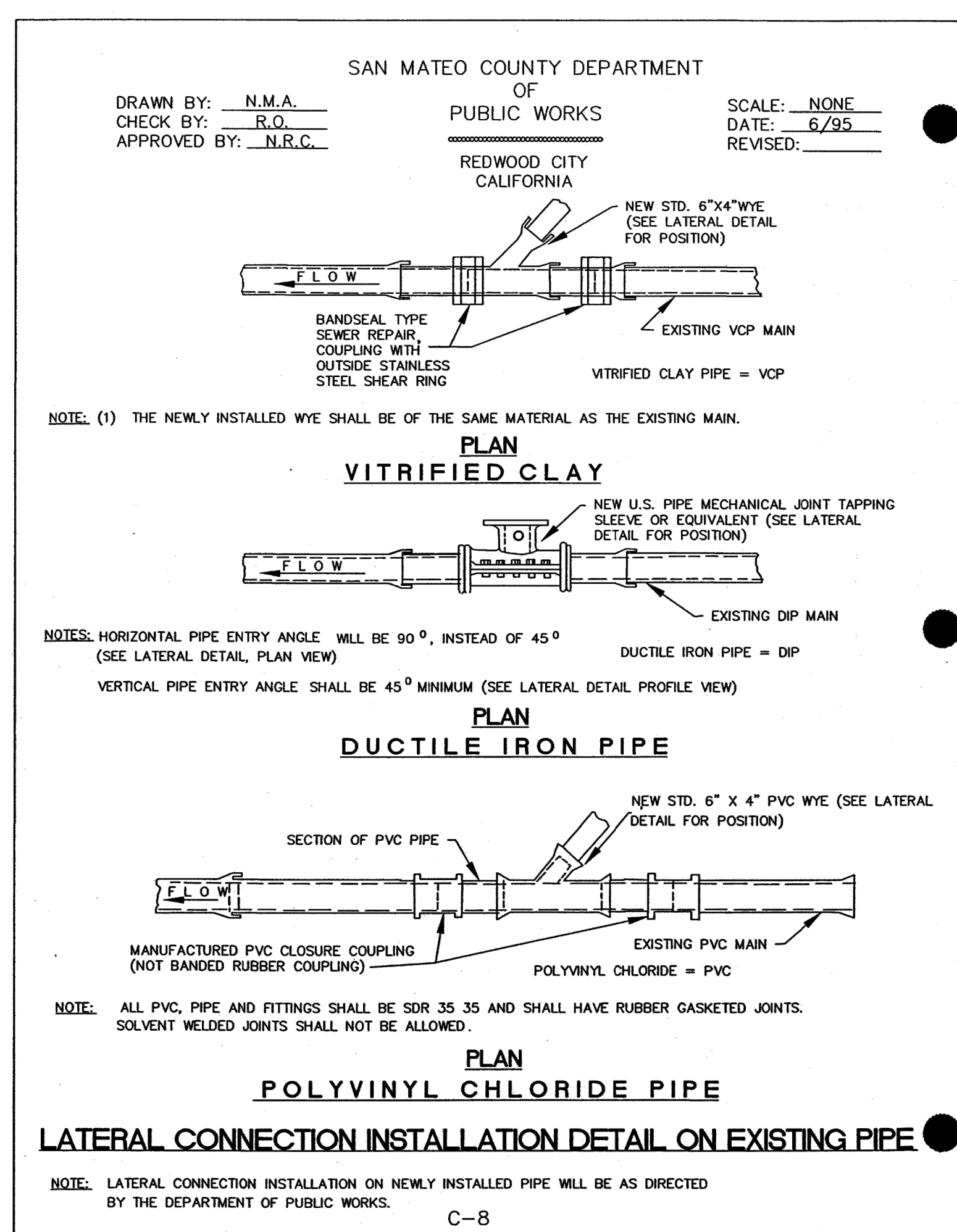
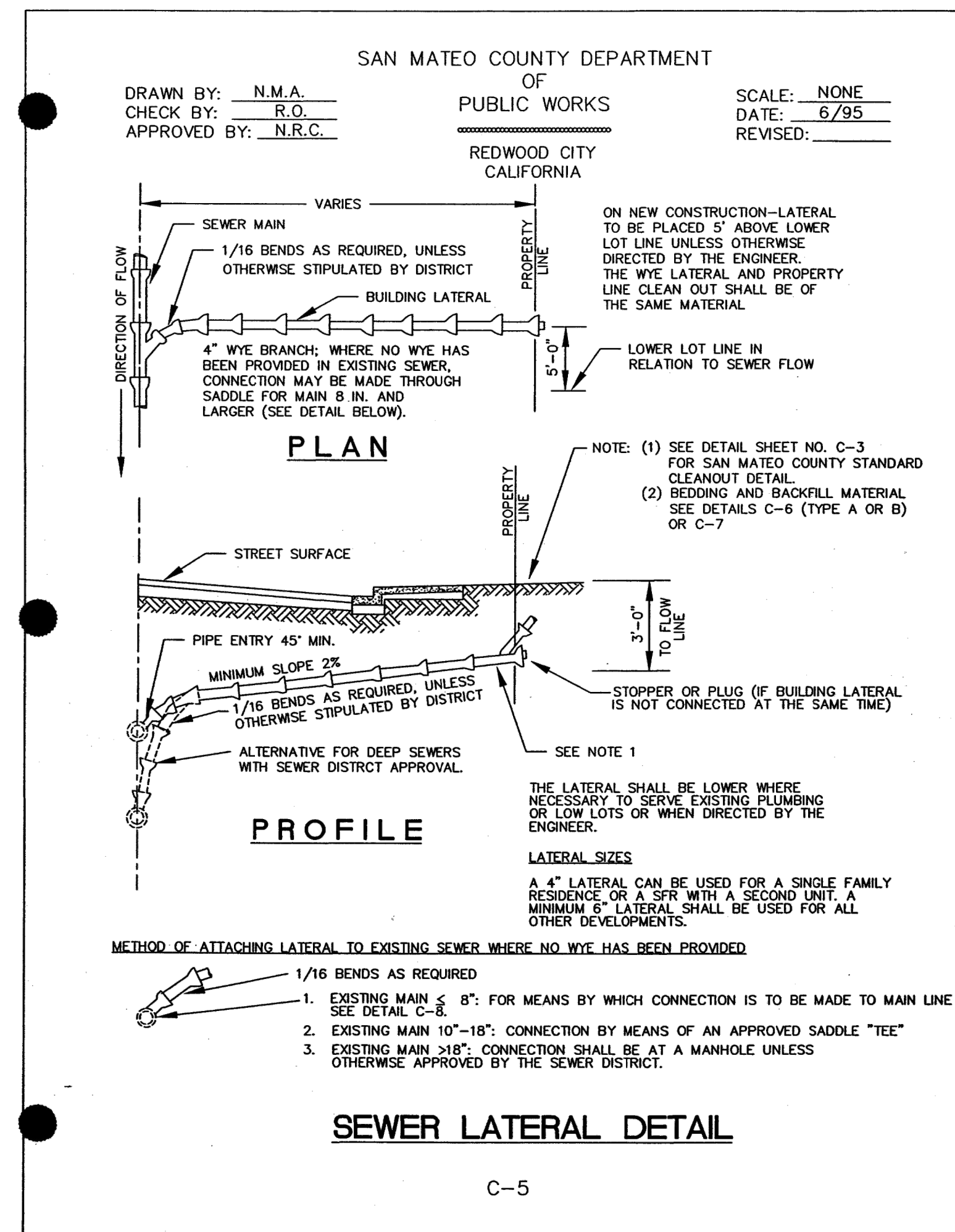
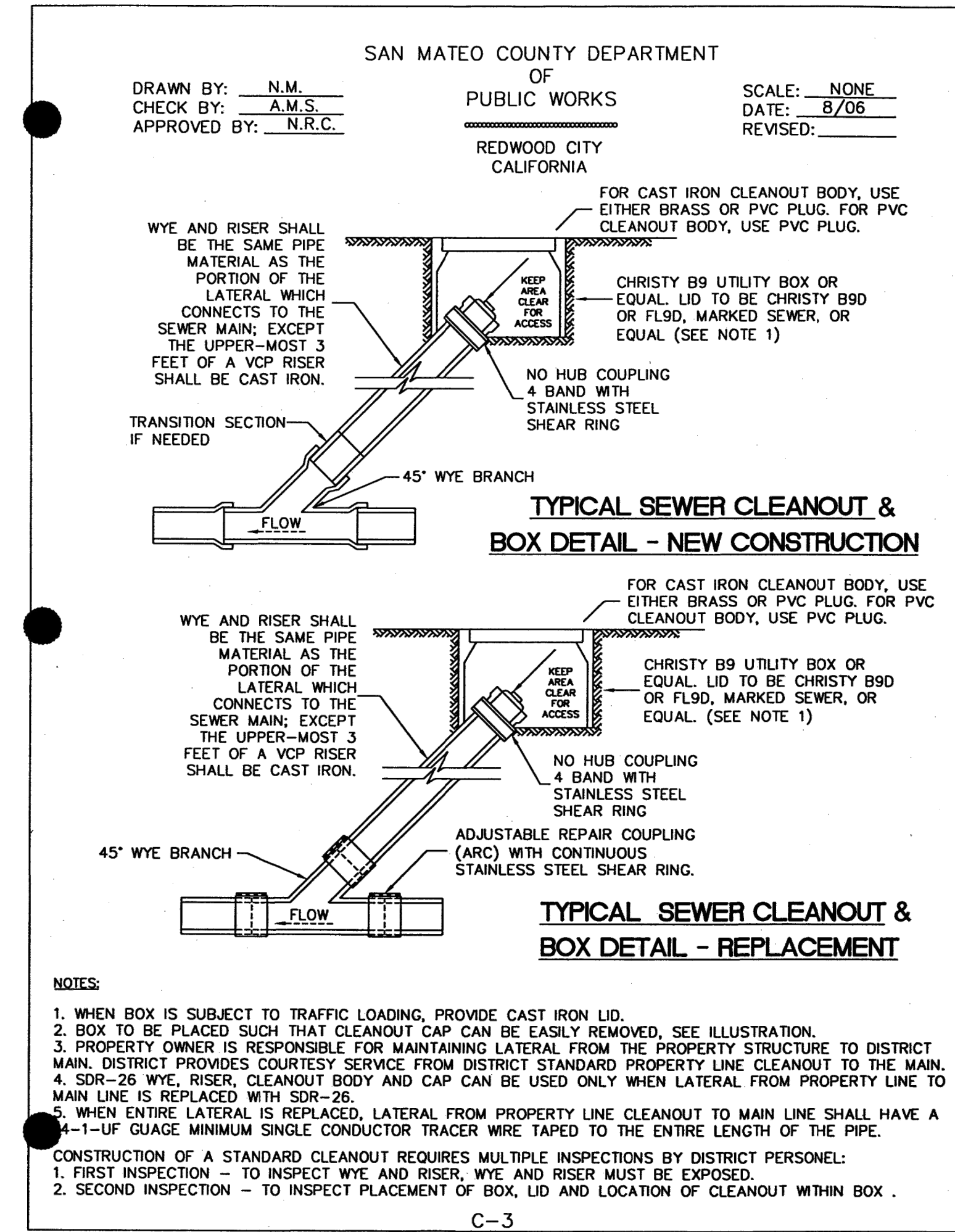
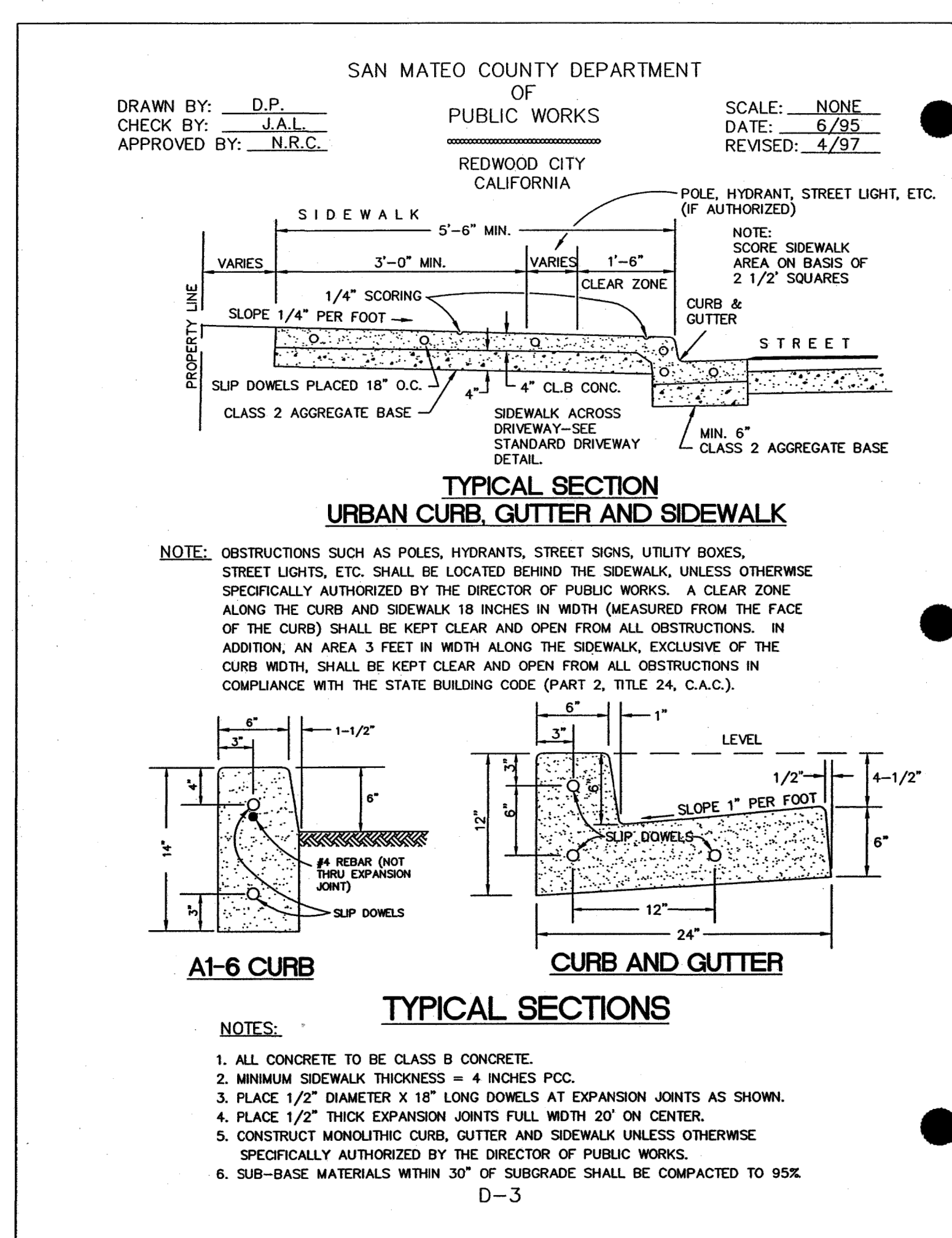
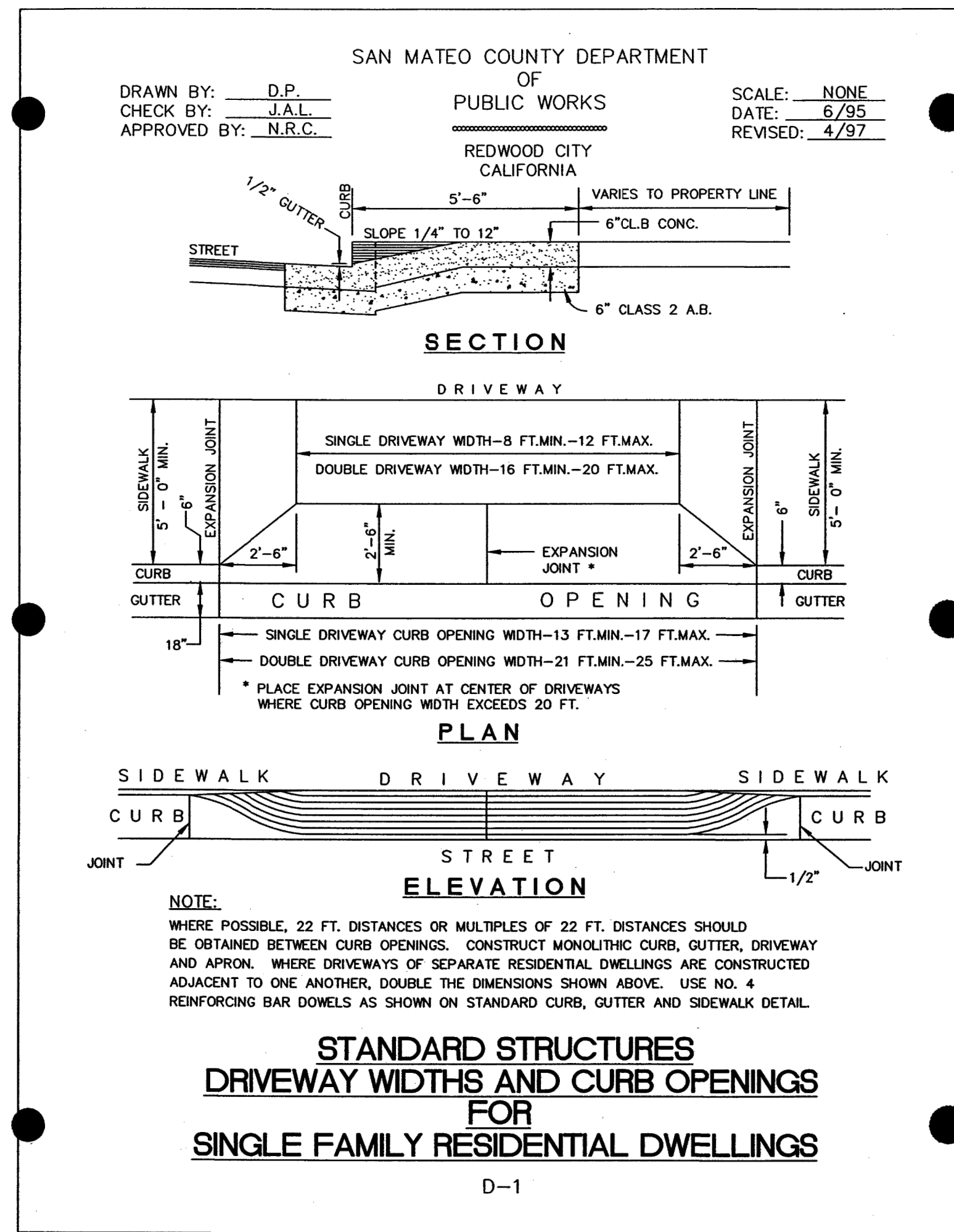

PER COUNTY'S COMMENTS DATED 02/21/19

DESIGNED	DATE	DATE	DATE
PT	02/06/19	02/06/19	02/06/19
CHECKED	DATE	DATE	DATE
ML	02/06/19	02/06/19	02/06/19

REVISIONS

BY DATE APP'D

FILE NO. 7 OF 7

DRAWING NO. C7

PROJECT NO. 396 3RD AVENUE

CONTRACT NO. APN 060-083-360

Redwood City California

ENGINEERING

598 E Santa Clara St #270
San Jose, CA 95112
Phone: (408) 806-7187
Fax: (408) 583-4006

REVIEWED
By William Saxton at 6:36 am, May 05, 2020

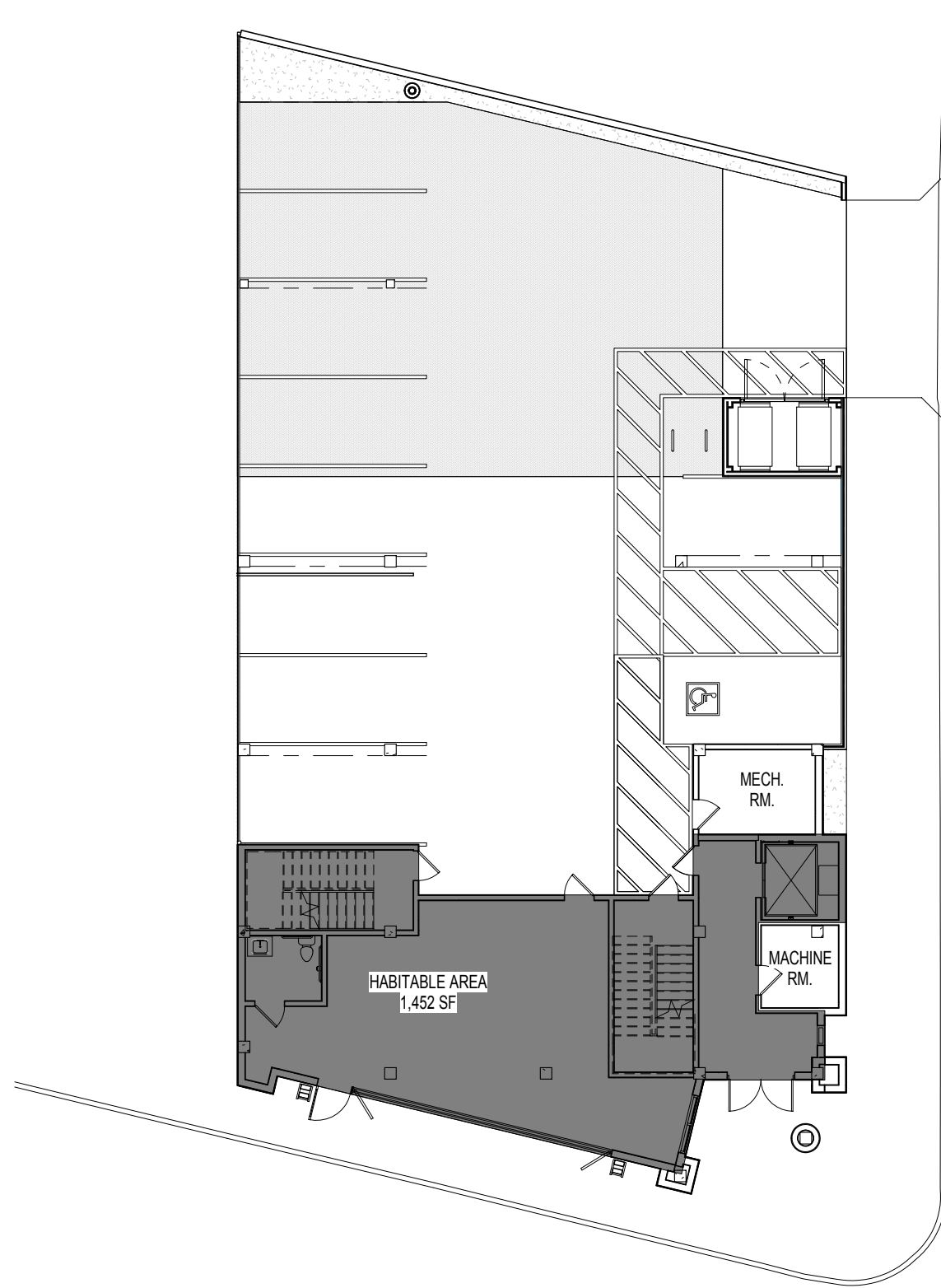

1 Floor Area Ratio Diagram, Level 1
1/16" = 1'-0"

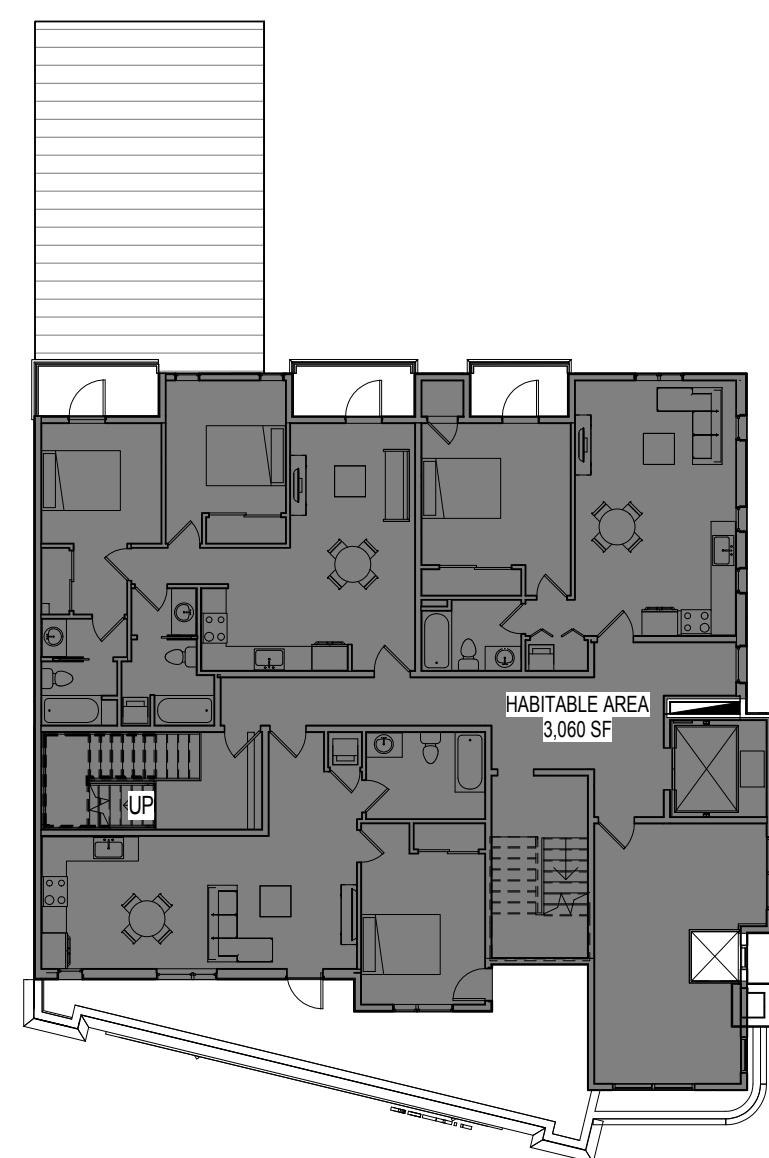

2 Floor Area Ratio Diagram, Level 2
1/16" = 1'-0"

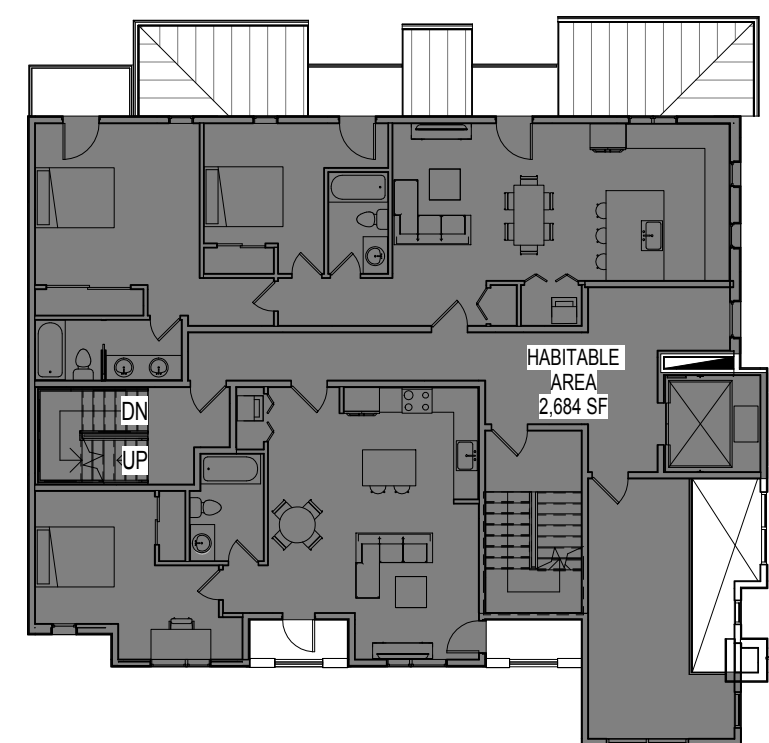

3 Floor Area Ratio Diagram, Level 3
1/16" = 1'-0"

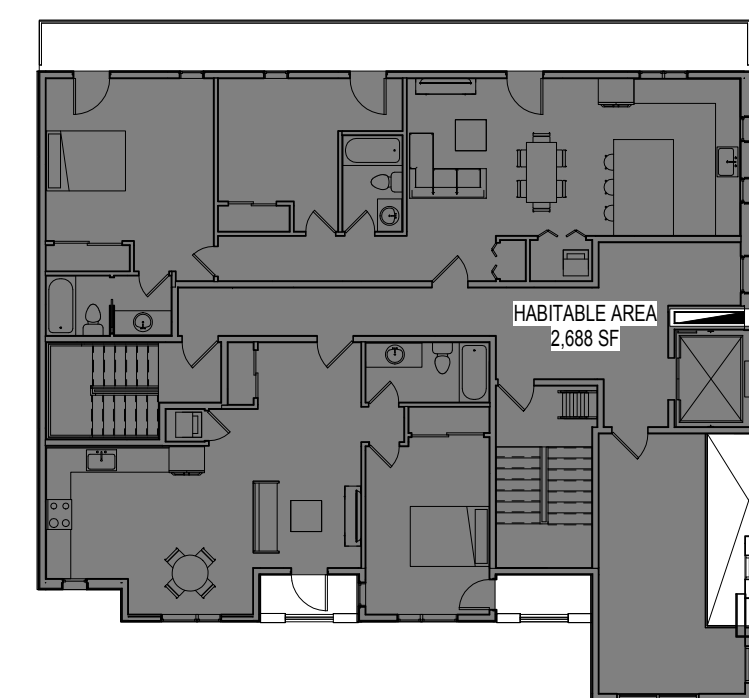

4 Floor Area Ratio Diagram, Level 4
1/16" = 1'-0"

F.A.R. ANALYSIS:

PER SAN MATEO COUNTY ZONING REGULATIONS: MMU DISTRICT, SECTION 6394-4, MAXIMUM BUILDING FLOOR AREA SPECIFICALLY INCLUDES: (1) THE FLOOR AREA OF ALL STORIES, EXCLUDING NON-HABITABLE SPACE, AS MEASURED FROM THE OUTSIDE FACE OF ALL EXTERIOR WALLS, AND (2) ALL OTHER AREAS COVERED BY A WATERPROOF ROOF WHICH EXTENDS FOUR OR MORE FEET FROM EXTERIOR WALLS. OVER THE AREA OF ALL DECKS, PORCHES, AND BALCONIES. FULLY ENCLOSED PARKING AREAS SHALL BE EXCLUDED FROM MAXIMUM BUILDING FLOOR AREA.

MAX. BUILDING FLOOR AREA
MIXED-USE DEVELOPMENT: 150% X 6,598 SF = 9,897 SF

BUILDING SIZES:

LEVEL 1: 1,452 SF
LEVEL 2: 3,060 SF
LEVEL 3: 2,684 SF
LEVEL 4: 2,688 SF

TOTAL: 9,884 SF < 9,897 SF = OKAY

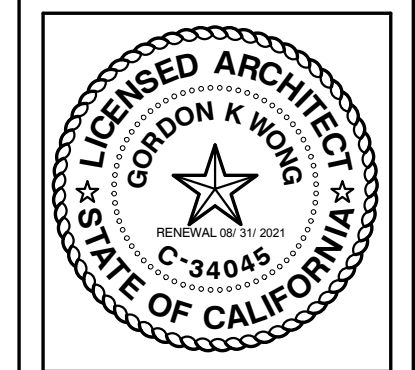

WIRAN JIA, JENNY C. WONG & DANNA BAHABIRAL, DESIGNER
GKW ARCHITECTS, INC.
710 S. MCCLINTOCK LANE, SUITE 108, CAMPBELL, CA 95008
(408) 783-1481 WWW.GKWARCHITECTS.COM

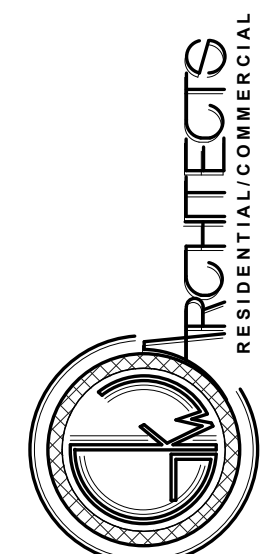

Floor Plan Analysis

396 Third Ave
Mixed-Use Development
396 Third Ave, Redwood City, CA 94063

Project Schedule Revision

Rev. #	Date	Description
2019.10.31	2019.10.31	Planning, Geo., PW
2019.10.31	2019.10.31	File
2020.02.05	2020.02.05	File

Floor Plan Analysis

A003

SCALE 1/16" = 1'-0"

2/6/2020 9:57:38 AM

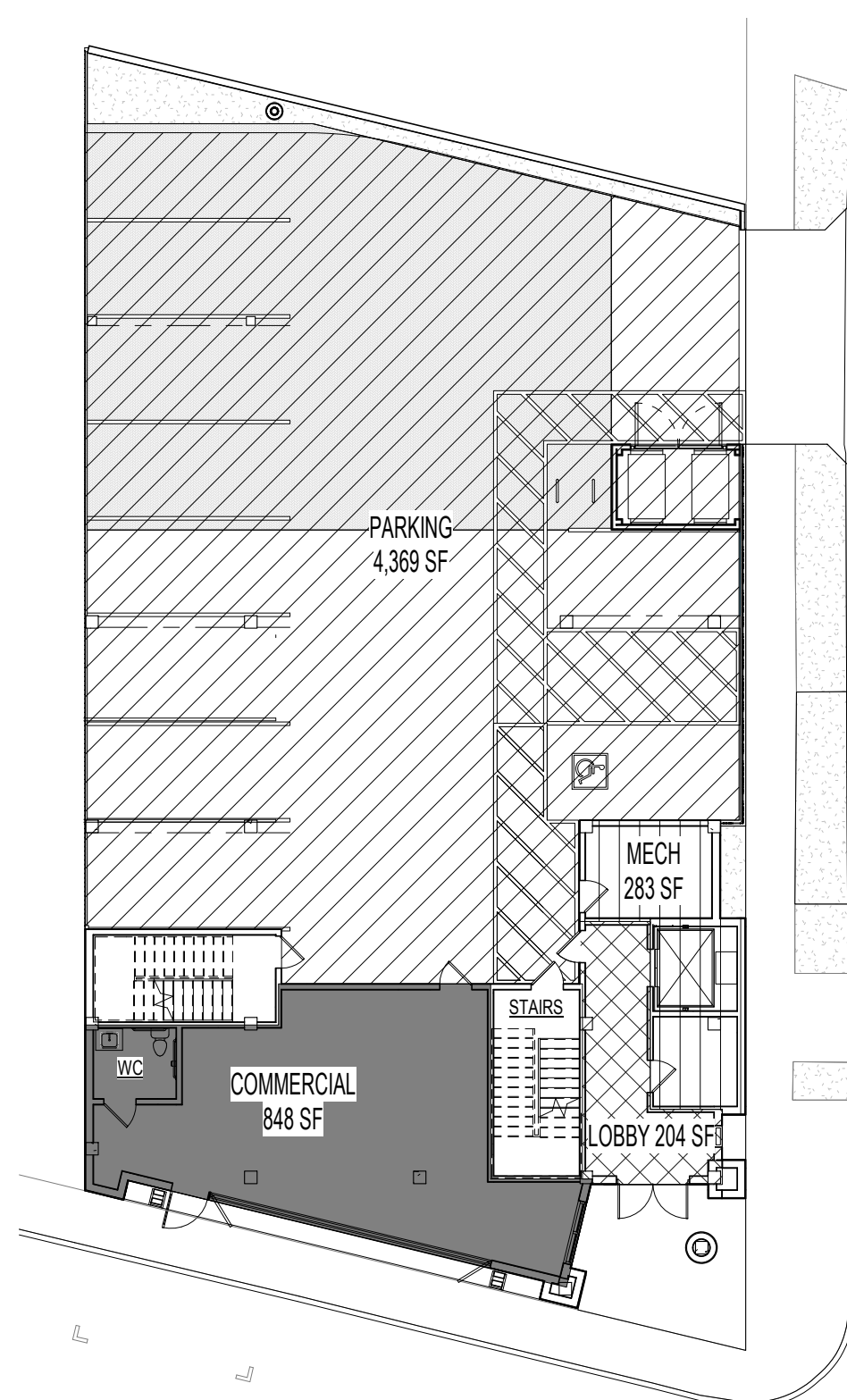

5 Floor Plan Analysis, Level 1
1/16" = 1'-0"

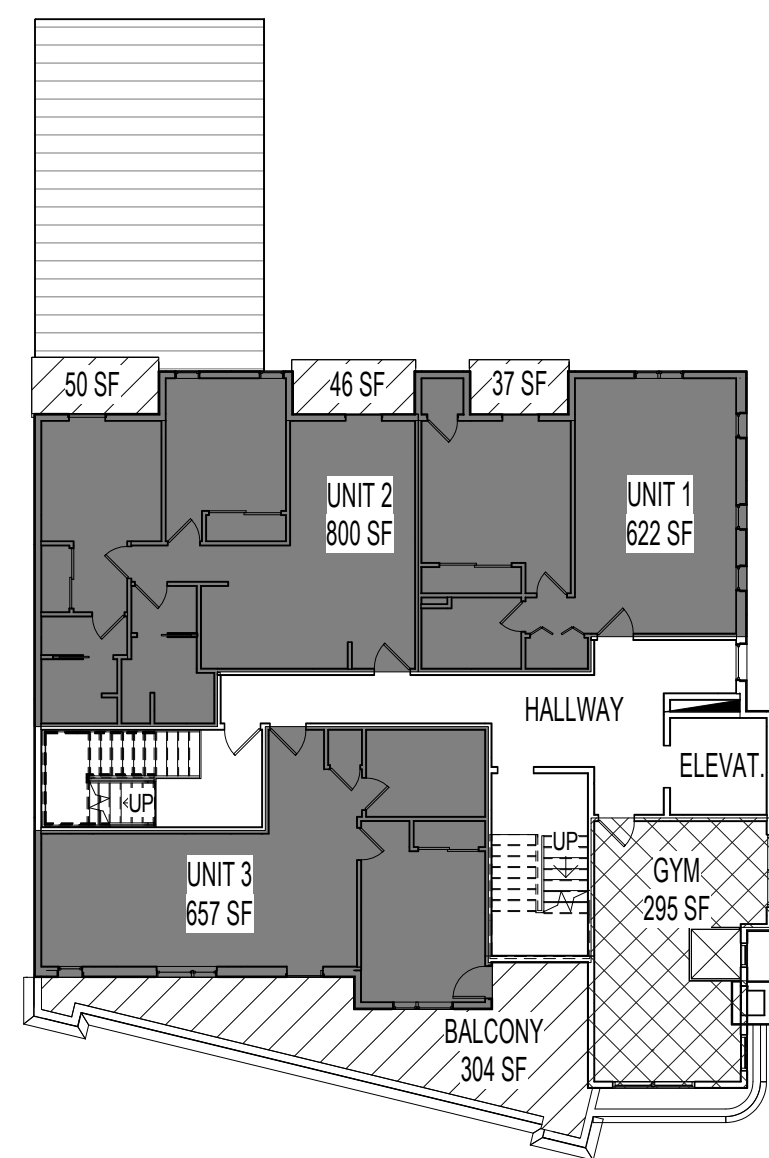

6 Floor Plan Analysis, Level 2
1/16" = 1'-0"

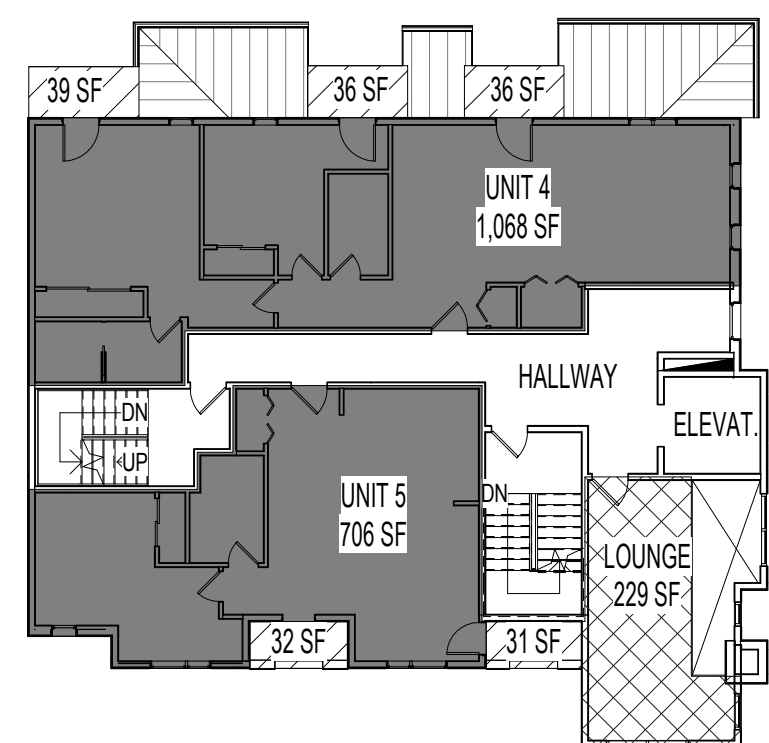

7 Floor Plan Analysis, Level 3
1/16" = 1'-0"

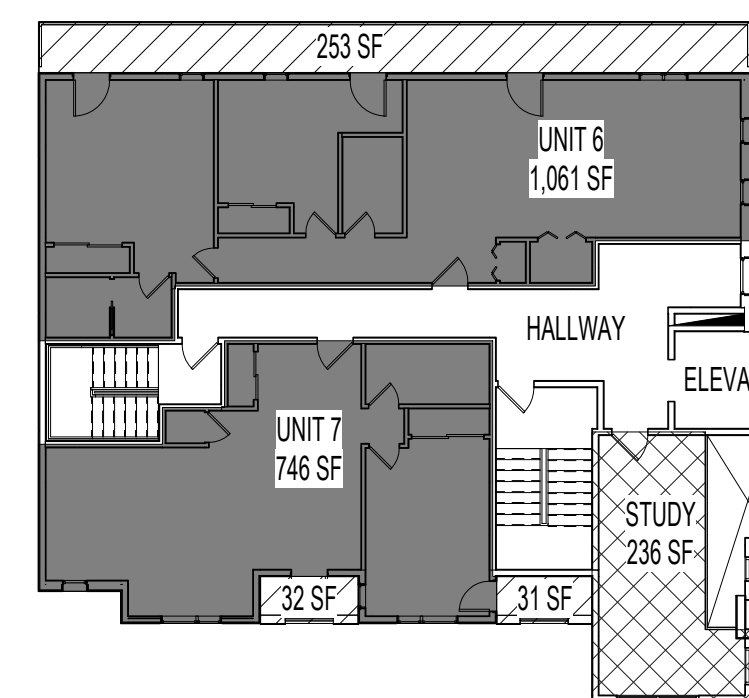

8 Floor Plan Analysis, Level 4
1/16" = 1'-0"

INCLUSIONARY REQUIREMENT PER MUNICIPAL CODE SECTION 7911:
20% OF THE TOTAL UNITS CONSTRUCTED SHALL BE DESIGNATED FOR SALE OR RENT TO EXTREMELY LOW, VERY LOW, LOW OR MODERATE-INCOME HOUSEHOLD.

20% X 7 = 1.4
AFFORDABLE UNIT
REQUIRED = 1
PROVIDED = 1 (UNIT 5 - 779 SF) = OKAY

FLOOR PLAN ANALYSIS - LEVEL 1

	AREA (SF)	STORGE / UTLY	BATH (#)
PARKING	4,369	1	-
COMMERCIAL	848	1	1
LOBBY	643	1	-
MECH	283	1	-

FLOOR PLAN ANALYSIS - LEVEL 2

	LIVING (SF)	BALCONY (SF)	TOTAL (SF)	BDRM (#)	BATH (#)
UNIT 1	622	37	659	1	1
UNIT 2	800	96	896	2	2
UNIT 3	657	304	961	1	1
GYM	295	-	295	-	-

FLOOR PLAN ANALYSIS - LEVEL 3

	LIVING (SF)	BALCONY (SF)	TOTAL (SF)	BDRM (#)	BATH (#)
UNIT 4	1,068	111	1,179	2	2
UNIT 5	706	63	779	1	1
LOUNGE	229	-	229	-	-

FLOOR PLAN ANALYSIS - LEVEL 4

	LIVING (SF)	BALCONY (SF)	TOTAL (SF)	BDRM (#)	BATH (#)
UNIT 6	1,061	253	1,314	2	2
UNIT 7	726	63	789	1	1
STUDY	236	-	236	-	-

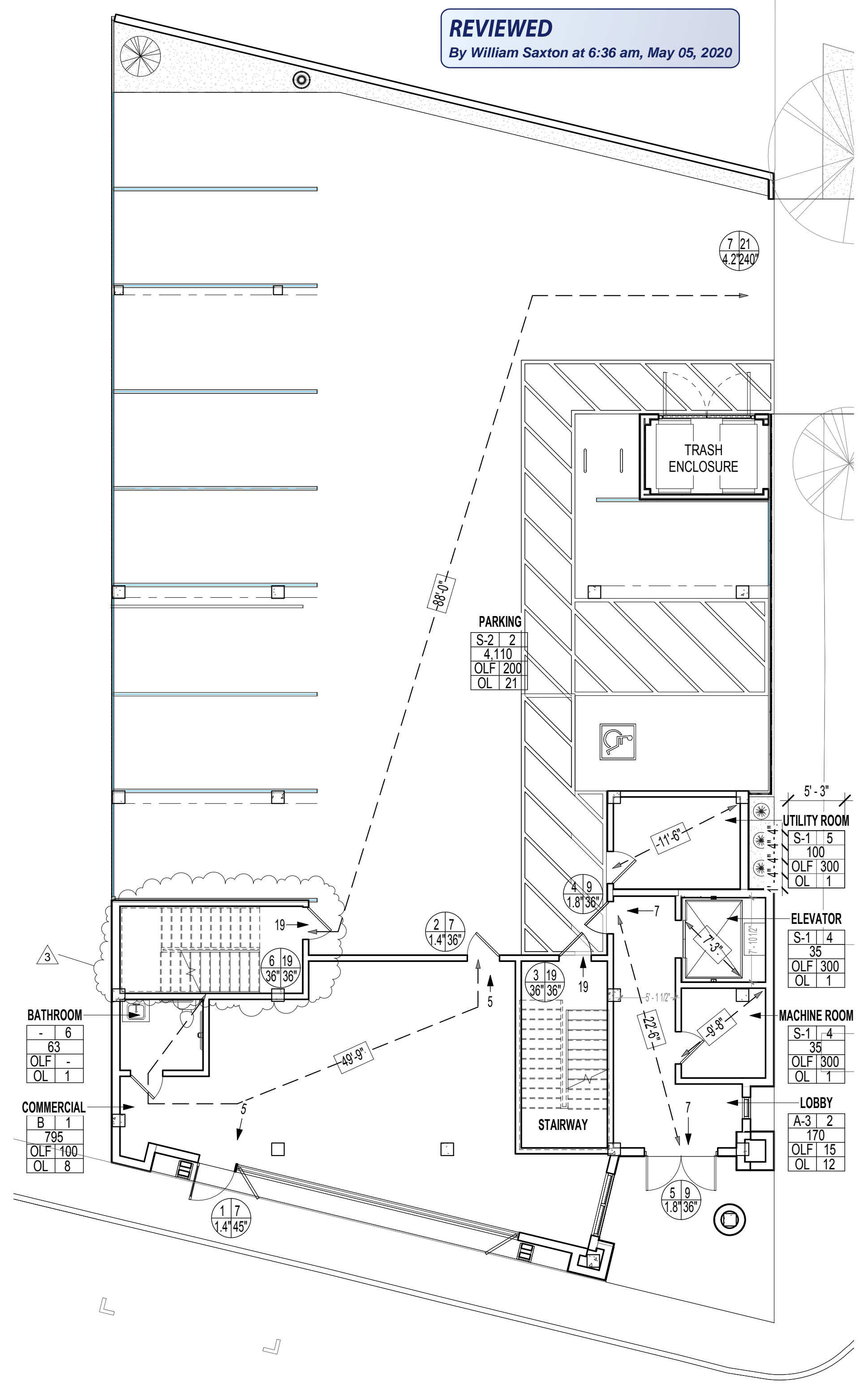

REVIEWED
By William Saxton at 6:36 am, May 05, 2020

Level 1, Egress Plan
1/8" = 1'-0"

OLF LEGEND

Occupancy Group	Room Ref. Number	Approximate Area	Occupancy Load Factor	# of Occupants
B	1	795	100	8
A	3	170	15	12
S	2	4,110	200	21

EXIT TRAVEL DISTANCE PER CBC 1017.2

--- # - # ---

EXIT WIDTH REQUIRED OTHER THAN STAIRWAYS

EXIT #

OF OCCUPANTS

PROVIDED EXIT WIDTH

REQUIRED EXIT WIDTH

MEANS OF EGRESS ANALYSIS:
OCCUPANT LOAD - PER CBC SECTION 1004.1.2:

MAX. FLOOR AREA ALLOWANCE PER OCCUPANT - PER CBC TABLE 1004.1.2

FUNCTION OF SPACE	OLF (SF / PERSON)
BUSINESS	100 GROSS
ASSEMBLY WITHOUT FIXED SEATS UNCONCENTRATED (TABLES & CHAIRS)	15 NET
STORAGE, MECHANICAL EQUIPMENT ROOM	300 GROSS
PARKING GARAGES	200 GROSS

COMMERCIAL=	795 / 100	=	8
LOBBY =	170 / 15	=	12
PARKING=	4,110 / 200	=	21
MACHINE ROOM=	65 SF / 300	=	1
UTILITY ROOM=	100 SF / 300	=	1
ELEVATOR=	35 SF / 300	=	1
BATHROOM=	48 SF	=	1

1ST LEVEL OCCUPANT LOAD = 45

NUMBER OF EXITS ANALYSIS:

PER CBC 1006.3.2.2, ROOMS, AREAS, AND SPACES, AT THE LEVEL OF EXIT DISCHARGE, COMPLYING WITH SECTION 1006.2.1 WITH EXITS THAT DISCHARGE DIRECTLY TO THE EXTERIOR, ARE PERMITTED TO HAVE ONE EXIT.

SPACE WITH ONE EXIT OR EXIT ACCESS DOORWAY - TABLE 1006.2.1

OCCUPANCY	MAX. OCCUPANT LOAD OF SPACE	MAX. COMMON PATH OF EGRESS TRAVEL DISTANCE (FEET)	
		WITH SPRINKLER SYSTEM (FEET)	WITHOUT SPRINKLER SYSTEM (FEET)
B	49	100	75
A	49	75	100
S	29	100	125
R-2	10	125	

NP = NOT PERMITTED

SPACE	OCCUPANCY	COMMON PATH OF EGRESS TRAVEL (PROPOSED, ALLOWED)	OCCUPANT LOAD (PROPOSED, ALLOWED)	NO. OF EXITS (PROPOSED, REQUIRED)	CHECK
COMMERCIAL	B	(49'-9", 100'-0")	(8, 49)	(2, 1)	OKAY
LOBBY	A	(22'-6", 75'-0")	(12, 29)	(2, 1)	OKAY
PARKING	S	(88'-0", 100'-0")	(21, 100)	(1, 1)	OKAY
MACHINE RM	S	(9'-8", 100'-0")	(1, 29)	(1, 1)	OKAY
UTILITY RM	S	(11'-6", 100'-0")	(1, 29)	(1, 1)	OKAY
ELEVATOR	S	(7'-3", 100'-0")	(1, 29)	(1, 1)	OKAY

EGRESS TRAVEL DISTANCE PER CBC TABLE 1006.3.2(1)

STORY	OCCUPANCY	MAXIMUM NUMBER OF DWELLING UNITS	MAXIMUM COMMON PATH OF EGRESS TRAVEL DISTANCE
FOURTH STORY ABOVE GRADE PLANE AND HIGHER	R-3A	N/A	125'-0"

A = BUILDINGS CLASSIFIED AS GROUP R-2 EQUIPPED THROUGHOUT WITH AN AUTOMATIC FIRE SPRINKLER SYSTEM IN ACCORDANCE WITH SECTION 903.3.1.1 OR 903.3.1.2 AND PROVIDED WITH EMERGENCY ESCAPE AND RESCUE OPENINGS IN ACCORDANCE WITH SECTION 1030.

MIXED OCCUPANCIES SEPARATION

- BUILDING EQUIPPED THROUGHOUT WITH AN AUTOMATIC SPRINKLER SYSTEM SHALL REQUIRE A 1 HOUR FIRE SEPARATION. (PER CBC 2016 TABLE 508.4)
- AUTOMATIC SPRINKLER SYSTEMS SHALL BE DESIGNED AND INSTALLED IN ACCORDANCE WITH CBC 2016 SECTION 903.3.1 THROUGH 903.3.6.
- 1-HOUR FIRE BARRIERS OR HORIZONTAL ASSEMBLIES USED FOR INCIDENTAL USE SEPARATIONS IN BUILDING OF TYPE IIB, IIBB, AND VB CONSTRUCTION IS NOT REQUIRED TO BE FIRE-RESISTANCE RATED UNLESS REQUIRED BY OTHER SECTIONS OF THIS CODE. (PER SECTION 509.4.1)
- FIRE PARTITIONS SHALL HAVE A FIRE-RESISTANCE RATING OF NOT LESS THAN 1 HOUR. (PER SECTION 708.3)
- DWELLING UNIT AND SLEEPING UNIT SEPARATIONS IN BUILDINGS OF TYPE VB CONSTRUCTION SHALL HAVE FIRE-RESISTANCE RATINGS OF NOT LESS THAN 1/2 HOUR IN BUILDINGS THROUGHOUT WITH AN AUTOMATIC SPRINKLER SYSTEM IN ACCORDANCE WITH SECTION 903.3.1. (PER SECTION 708.3, EXCEPTION 2)
- WHERE THE HORIZONTAL ASSEMBLY SEPARATES MIXED OCCUPANCIES, THE ASSEMBLY SHALL HAVE A FIRE-RESISTANCE RATING OF NOT LESS THAN THAT REQUIRED BY SECTION 508.4 BASED ON THE OCCUPANCIES BEING SEPARATED.

TABLE 508.4 REQUIRED SEPARATION OF OCCUPANCIES (HOURS)
BUILDINGS EQUIPPED THROUGHOUT WITH AN AUTOMATIC SPRINKLER SYSTEM

OCCUPANCY	A	R-2	S-2	CHECK
A	NO REQUIREMENT	-	-	OKAY
R-2	1	NO REQUIREMENT	-	OKAY
S-2	1	1	NO REQUIREMENT	OKAY

ACCESSIBLE MEANS OF EGRESS REQUIRED - PER CBC 1009.1:
ACCESSIBLE MEANS OF EGRESS SHALL COMPLY WITH CBC SECTION 1009. ACCESSIBLE SPACES SHALL BE PROVIDED WITH NOT LESS THAN ONE ACCESSIBLE MEANS OF EGRESS.

STAIRWAYS - PER CBC 1009.3:

AN ACCESSIBLE STAIRWAY BETWEEN STORIES SHALL HAVE A CLEAR WIDTH OF 48 INCHES MINIMUM BETWEEN HANDRAILS AND SHALL EITHER INCORPORATE AN AREA OF REFUGE WITHIN AN ENLARGE FLOOR-LEVEL LANDING OR SHALL BE ACCESSIBLE FROM AN AREA OF REFUGE COMPLYING WITH SECTION 1009.6. EXIT STAIRWAYS SHALL COMPLY WITH CHAPTER 11A, SECTION 1123A.

- EXCEPTIONS:
- THE CLEAR WITH OF 48 INCHES BETWEEN HANDRAILS IS NOT REQUIRED IN BUILDINGS EQUIPPED THROUGHOUT WITH AN AUTOMATIC SPRINKLER SYSTEM INSTALLED IN ACCORDANCE WITH SECTION 903.3.1.1 OR 903.3.1.2
 - AREAS OF REFUGE ARE NOT REQUIRED AT STAIRWAYS IN BUILDINGS EQUIPPED THROUGHOUT WITH AN AUTOMATIC SPRINKLER SYSTEM INSTALLED IN ACCORDANCE WITH SECTION 903.3.1.1 OR 903.3.1.2
 - AREAS OF REFUGE ARE NOT REQUIRED AT STAIRWAYS SERVING OPEN PARKING GARAGES.
 - AREA OF REFUGE ARE NOT REQUIRED AT STAIRWAYS IN GROUP R-2 OCCUPANCIES.

STAIRWAYS, WIDTH & CAPACITY PER CBC SECTION 1011.2
THE REQUIRED CAPACITY OF STAIRWAYS SHALL BE DETERMINED AS SPECIFIED IN SECTION 1005.1, BUT THE MINIMUM WIDTH SHALL BE NOT LESS THAN 44 INCHES.
EXCEPTION: 1. STAIRWAYS SERVING OCCUPANT LOAD OF LESS THAN 50 SHALL HAVE A WIDTH OF NOT LESS THAN 36 INCHES

STAIRWAYS - PER CBC 1011:

PER CBC 1005.3.1 STAIRWAYS THE CAPACITY, IN INCHES, OF MEANS OF EGRESS STAIRWAYS SHALL BE CALCULATED BY MULTIPLYING THE OCCUPANT LOAD SERVED BY SUCH STAIRWAYS BY A MEANS OF EGRESS CAPACITY FACTOR OF 0.3 INCH PER OCCUPANT.

PER CBC 1011.2 THE MINIMUM WIDTH OF STAIRWAYS SHALL BE NOT LESS THAN 44 INCHES.
EXCEPTIONS: STAIRWAYS SERVING AN OCCUPANT LOAD OF LESS THAN 50 SHALL HAVE A WIDTH OF NOT LESS THAN 36 INCHES.

PER CBC 1011.3 STAIRWAYS SHALL HAVE A HEADROOM CLEARANCE OF NOT LESS THAN 80 INCHES.

PER CBC 1011.5.2 STAIR RISER HEIGHTS SHALL BE 7 INCHES MAXIMUM. RECTANGULAR TREAD DEPTHS SHALL BE 11 INCHES MINIMUM. EXCEPTION: THE MAXIMUM RISER HEIGHT SHALL BE 7.75 INCHES, THE MINIMUM TREAD DEPTH SHALL BE 10 INCHES WITHIN DWELLING UNITS IN GROUP R-2 OCCUPANCIES.

PER 1011.6 THE WIDTH OF THE STAIRWAY LANDING SHALL BE NOT LESS THAN THE WIDTH OF THE STAIRWAYS SERVED.

THE CAPACITY IN INCHES, OF MEANS OF EGRESS COMPONENTS, OF OTHER THAN STAIRWAYS:

COMMERCIAL:

EXIT #1
9 OCCUPANTS EXITING
EXIT WIDTH REQUIRED = 9 X 0.2 = 1.8"
EXIT WIDTH PROVIDED = 45" > 1.8" = OKAY

EXIT #2
9 OCCUPANTS EXITING
EXIT WIDTH REQUIRED = 9 X 0.2 = 1.8"
EXIT WIDTH PROVIDED = 36" > 1.8" = OKAY

CORRIDOR

EXIT #3
38 OCCUPANTS EXITING
EXIT WIDTH REQUIRED = 38 X 0.2 = 7.6"
EXIT WIDTH PROVIDED = 75" > 7.6" = OKAY

EXIT #6
38 OCCUPANTS EXITING
EXIT WIDTH REQUIRED = 38 X 0.2 = 7.6"
EXIT WIDTH PROVIDED = 75" > 7.6" = OKAY

LOBBY

EXIT #4
14 OCCUPANTS EXITING
EXIT WIDTH REQUIRED = 14 X 0.2 = 1.4"
EXIT WIDTH PROVIDED = 75" > 1.4" = OKAY

EXIT #5
14 OCCUPANTS EXITING
EXIT WIDTH REQUIRED = 14 X 0.2 = 1.4"
EXIT WIDTH PROVIDED = 75" > 1.4" = OKAY

GARAGE

EXIT #7
21 OCCUPANTS EXITING
EXIT WIDTH REQUIRED = 21 X 0.2 = 4.2"
EXIT WIDTH PROVIDED = 240" > 4.2" = OKAY

THE CAPACITY IN INCHES, OF MEANS OF EGRESS STAIRWAYS:

LEVEL 1:

38 OCCUPANTS EXITING
EXIT WIDTH REQUIRED = 38 X 0.3 = 11.4"
EXIT WIDTH PROVIDED = 36" > 11.4" = OKAY

DOORS - PER CBC 1010.1:

EGRESS DOORS SHALL BE READILY DISTINGUISHABLE FROM THE ADJACENT CONSTRUCTION AND FINISHES SUCH THAT THE DOORS ARE EASILY RECOGNIZABLE AS DOORS.

SIZE OF DOORS - PER CBC 1010.1.1:

THE REQUIRED CAPACITY OF EACH DOOR OPENING SHALL BE SUFFICIENT FOR THE OCCUPANT LOAD AND SHALL PROVIDE A MINIMUM CLEAR WIDTH OF 32 INCHES.

DOORS SWING - PER CBC 1010.1.2:

EGRESS DOORS SHALL BE OF THE PIVOTED OR SIDE-HINGED SWINGING TYPE. DOORS SHALL SWING IN THE DIRECTION OF EGRESS TRAVEL WHERE SERVING A ROOM OR AREA CONTAINING AN OCCUPANT LOAD OF 50 OR MORE PERSONS.

DOOR OPENING FORCE - PER CBC SECTION 1010.1.3:

THE FORCE FOR PUSHING AND PULLING THE DOOR OPEN SHALL BE MAXIMUM 5 POUNDS.

EXIT ACCESS TRAVEL DISTANCE - PER CBC 1017:

TRAVEL DISTANCE WITHIN THE EXIT ACCESS PORTION OF THE EGRESS SYSTEM SHALL BE IN ACCORDANCE WITH SECTION 1017 AND NOT EXCEED THE VALUES IN TABLE 1017.2.

EXIT ACCESS TRAVEL DISTANCE - PER CBC TABLE 1017.2

OCCUPANCY	WITH SPRINKLER SYSTEM
B	300 FEET
A, R, S-1	250 FEET
S-2	400 FEET

EXIT ACCESS TRAVEL DISTANCE

SPACE	OCCUPANCY	PROPOSED	MAXIMUM
COMMERCIAL	B	49'-9"	300'-0"
LOBBY	A	22'-6"	250'-0"
PARKING	S-2	88'-0"	200'-0"

CORRIDOR FIRE RESISTANCE RATING ANALYSIS - PER TABLE 1020.1:

LEVEL 1:

GROUP R-2: 38 OCC. > 10 OCC. = REQUIRED 1 HOUR RAITING

PORTABLE FIRE EXTINGUISHERS - PER CBC 906:

CBC 906.1:
• PORTABLE FIRE EXTINGUISHERS SHALL BE INSTALLED IN GROUP R-2, M AND S OCCUPANCY.

PORTABLE FIRE EXTINGUISHER - GENERAL REQUIREMENTS - PER CBC 906.2:

PORTABLE FIRE EXTINGUISHERS SHALL BE SELECTED AND INSTALLED IN ACCORDANCE WITH CBC SECTION 906.2 AND CALIFORNIA CODE OF REGULATION, TITLE 19, DIVISION 1, CHAPTER 3.

PORTABLE FIRE EXTINGUISHER - CONSPICUOUS LOCATION - PER CBC 906.5:

PORTABLE FIRE EXTINGUISHERS SHALL BE LOCATED IN CONSPICUOUS LOCATIONS WHERE THEY WILL BE READILY ACCESSIBLE AND IMMEDIATELY AVAILABLE FOR USE. THIS LOCATION SHALL BE ALONG NORMAL PATH OF TRAVEL, UNLESS THE FIRE CODE OFFICIAL DETERMINES THAT THE HAZARD POSED INDICATES THE NEED FOR PLACEMENT AWAY FROM NORMAL PATH OF TRAVEL.

FIRE ALARM AND DETECTION SYSTEM - WHERE REQUIRED - PER CBC SECTION 907:

AN APPROVED FIRE ALARM SYSTEM INSTALLED IN ACCORDANCE WITH THE CBC SECTION 907.2 AND NFPA 72 SHALL BE PROVIDED IN NEW BUILDINGS AND STRUCTURES IN ACCORDANCE WITH SECTIONS 907.2.1 THROUGH 907.2.23.



WERRAN JIA, JENNY C WONG & DANIA BAHARRA, DESIGNER
GHW ARCHITECTS, INC.
710 BUCKINGHAM LANE, SUITE 108, CAMPBELL, CA 95008
(408) 783-0481 | WWW.GHWARCHITECTS.COM

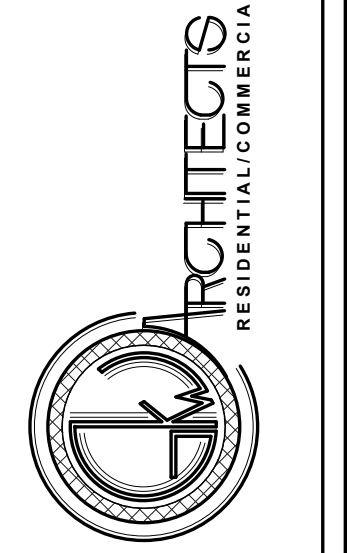

**396 Third Ave
Mixed-Use Development**
396 Third Ave., Redwood City, CA 94063

Project Schedule Revision

Rev. #	Date	Description
1	2019.10.31	Planning, Geo., PW
2	2019.10.31	Fire
3	2020.02.05	Fire

Occupancy & Egress Analysis, Level 1

A004

SCALE 1/8" = 1'-0"

2/6/2020 9:57:41 AM

APPROVED
By William Saxton at 6:35 am, May 05, 2020

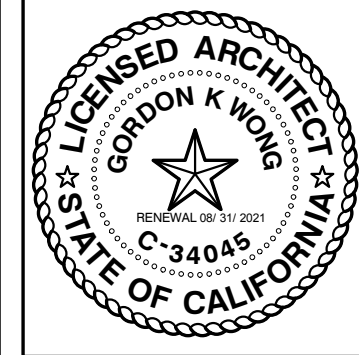

WIRAN JIA, JENNY C WONG & DANIA BAHARRA, DESIGNER
GKW ARCHITECTS, INC.
710 BUCKINGHAM LANE, SUITE 100, CAMBRIDGE, CA 95908
(415) 783-1481 WWW.GKWARCHITECTS.COM

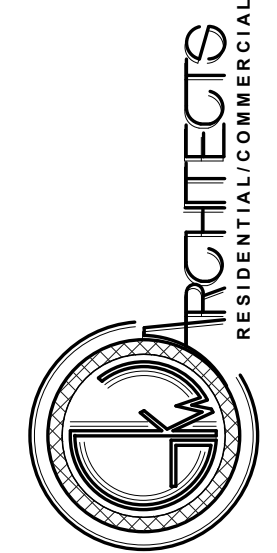

**396 Third Ave
Mixed-Use Development**
396 Third Ave., Redwood City, CA 94063

Rev. #	Date	Description
1	2019.10.31	Planning, Geo., PW
2	2019.10.31	Fire
3	2020.02.05	Fire

Occupancy & Egress Analysis, Levels 2-4

A005
SCALE 1/8" = 1'-0"
2/6/2020 9:57:45 AM

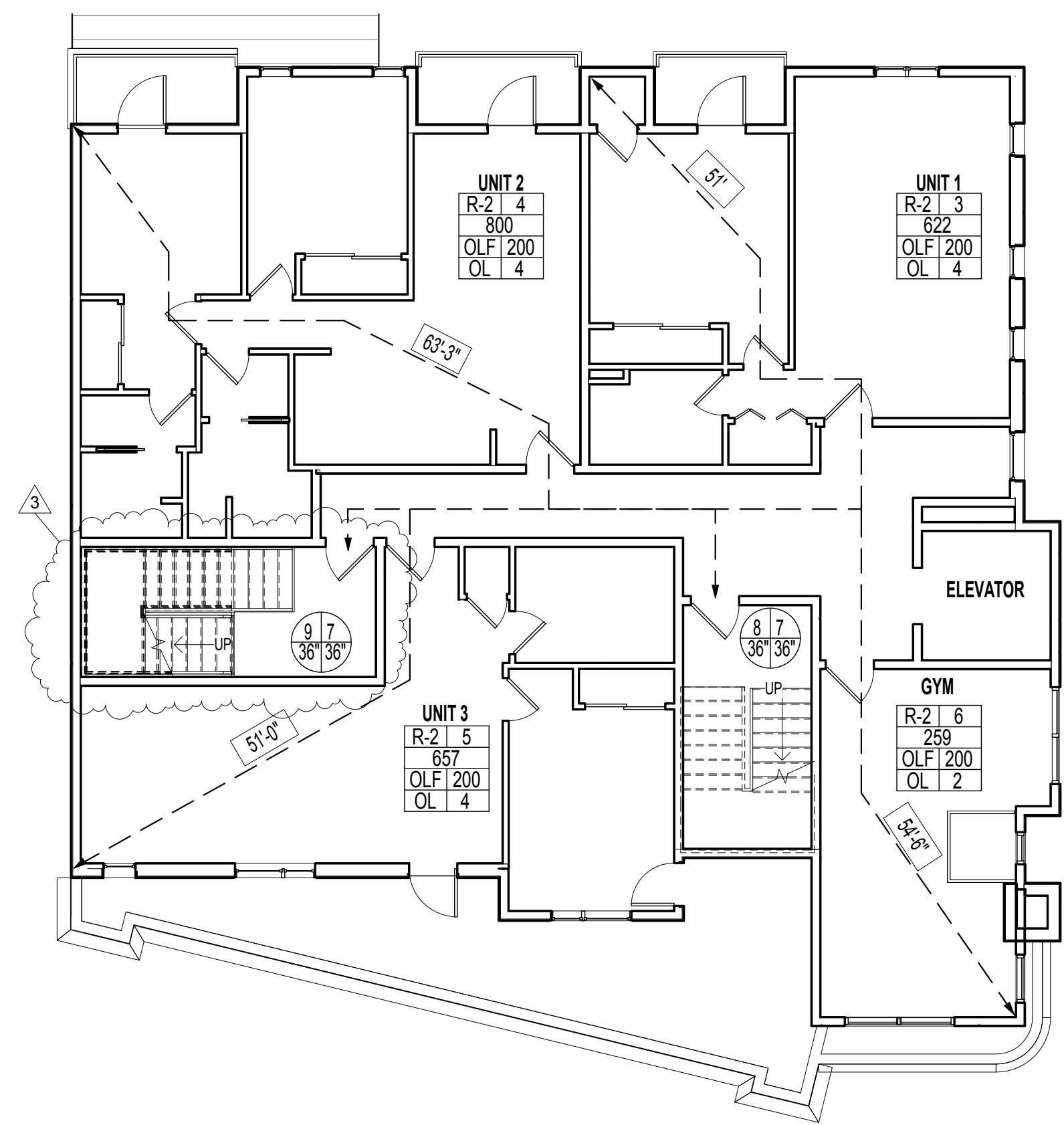

1 Level 2, Egress Plan
1/8" = 1'-0"

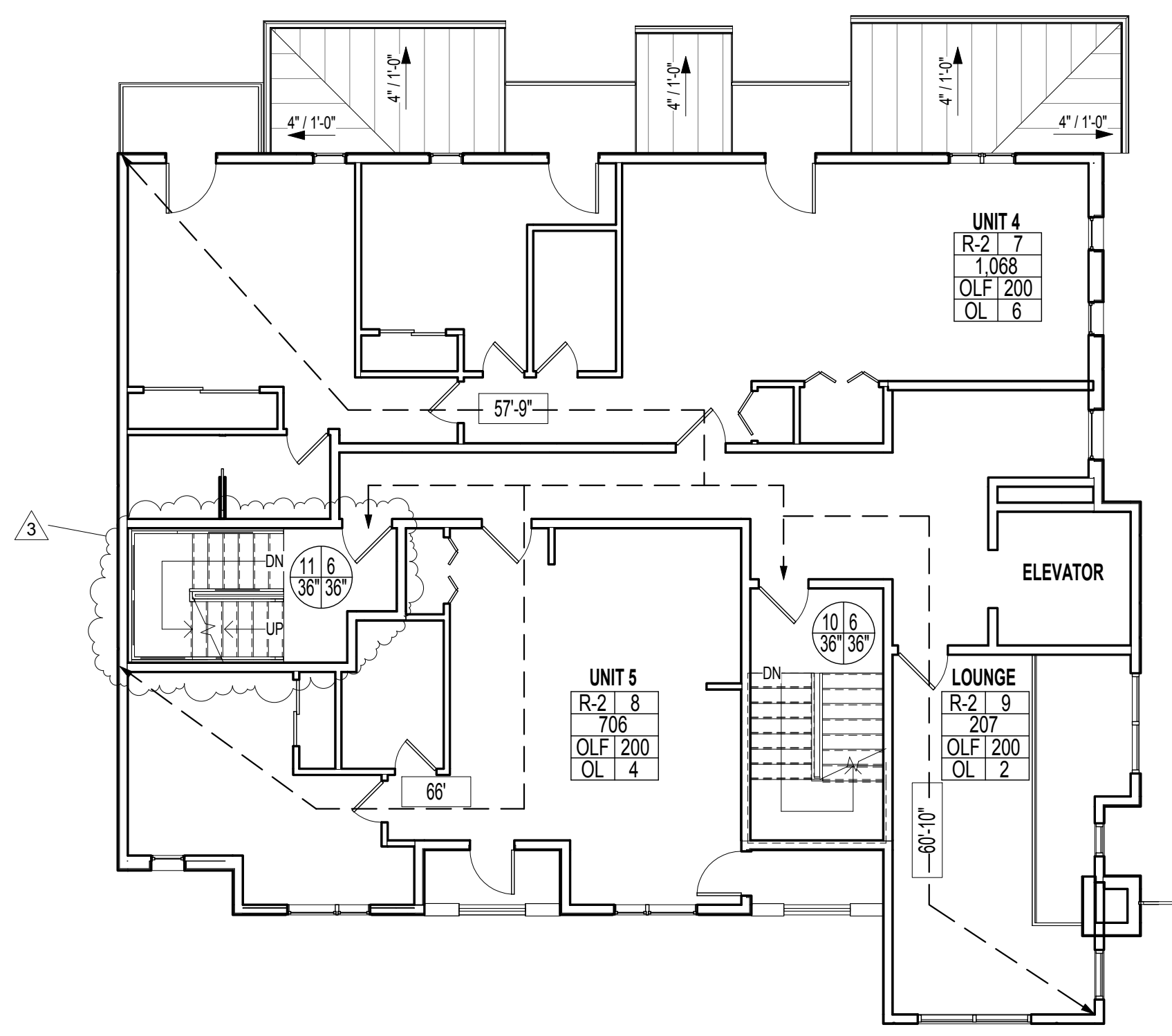

2 Level 3, Egress Plan
1/8" = 1'-0"

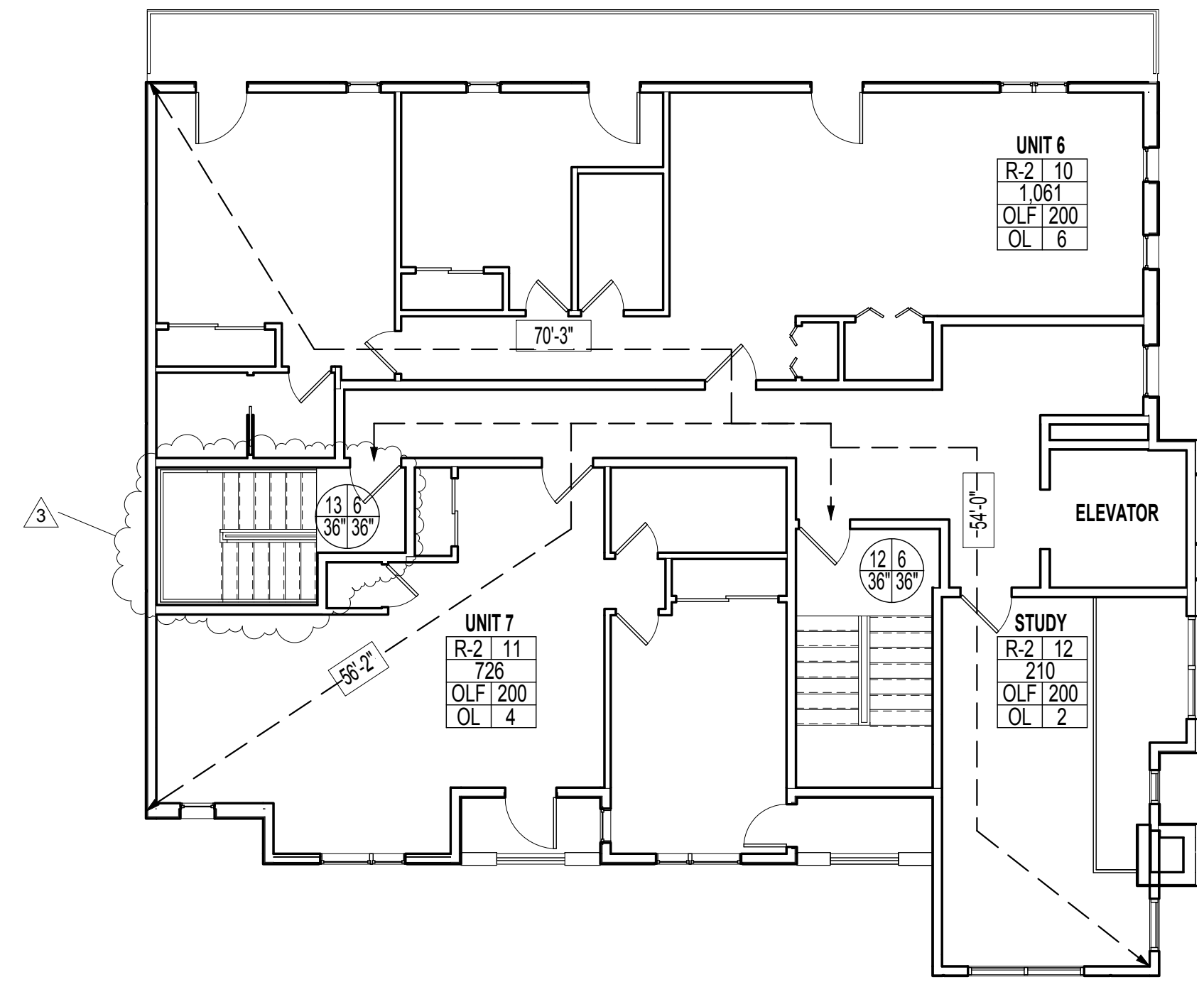

3 Level 4, Egress Plan
1/8" = 1'-0"

OCCUPANT LOAD - PER CBC SECTION 1004.1.2:

LEVEL 2 OCCUPANT COUNT:
UNIT 1 = 4 OCC
UNIT 2 = 4 OCC
UNIT 3 = 4 OCC
LOUNGE = 2 OCC

TOTAL = 14 OCC

LEVEL 3 OCCUPANT COUNT:
UNIT 4 = 6 OCC
UNIT 5 = 4 OCC
STUDY RM. = 2 OCC

TOTAL = 12 OCC

LEVEL 4 OCCUPANT COUNT:
UNIT 6 = 6 OCC
UNIT 7 = 4 OCC
GYM = 2 OCC

TOTAL = 12 OCC

TOTAL RESIDENTIAL (R-2) OCCUPANT COUNT:

LEVEL 1 = 45 OCC
LEVEL 2 = 14 OCC
LEVEL 3 = 12 OCC
LEVEL 4 = 12 OCC

GRAND TOTAL = 83 OCC

EGRESS TRAVEL DISTANCE PER CBC TABLE 1006.3.2(1)

STORY	OCCUPANCY	MAXIMUM NUMBER OF DWELLING UNITS	MAXIMUM COMMON PATH OF EGRESS TRAVEL DISTANCE
FOURTH STORY ABOVE GRADE PLANE AND HIGHER	R-3A	N/A	125'-0"

A = BUILDINGS CLASSIFIED AS GROUP R-2 EQUIPPED THROUGHOUT WITH AN AUTOMATIC FIRE SPRINKLER SYSTEM IN ACCORDANCE WITH SECTION 903.3.1.1 OR 903.3.1.2 AND PROVIDED WITH EMERGENCY ESCAPE AND RESCUE OPENINGS IN ACCORDANCE WITH SECTION 1030.

NUMBER OF EXITS ANALYSIS

LEVEL 2:
OCCUPANT: 14 OCC
MAX. EGRESS TRAVEL: 63'-3" < 125' = **OKAY**
EXIT NUMBER
REQUIRED: 2 EXIT
PROVIDED: 2 EXIT = **OKAY**

LEVEL 3:
OCCUPANT: 12 OCC
MAX. EGRESS TRAVEL: 66' < 125' = **OKAY**
EXIT NUMBER:
REQUIRED: 2 EXIT
PROVIDED: 2 EXIT = **OKAY**

LEVEL 4:
OCCUPANT: 12 OCC
MAX. EGRESS TRAVEL: 70'-3" < 125' = **OKAY**
EXIT NUMBER:
REQUIRED: 2 EXIT
PROVIDED: 2 EXIT = **OKAY**

EGRESS FROM STORIES/SINGLE EXITS - PER 1006.3.2:
A SINGLE EXIT OR ACCESS TO A SINGLE EXIT ACCESS SHALL BE PERMITTED FROM ANY STORY OR OCCUPIED ROOF WHERE ONE OF THE FOLLOWING CONDITIONS EXISTS:

- THE OCCUPANT LOAD, NUMBER OF DWELLING UNITS AND EXIT ACCESS TRAVEL DISTANCE DO NOT EXCEED THE VALUES IN TABLE 1006.3.2(1) OR 1006.3.2(2).
- ROOMS, AREAS AND SPACES, COMPLYING WITH SECTION 1006.2.1 WITH EXITS.

THE CAPACITY IN INCHES OF MEANS OF EGRESS STAIRWAYS:

LEVEL 2:
14 OCCUPANTS EXITING
EXIT WIDTH REQUIRED = 14 X 0.3 = 4.2"
EXIT WIDTH PROVIDED = 36" > 4.2" = **OKAY**

LEVEL 3:
12 OCCUPANTS EXITING
EXIT WIDTH REQUIRED = 12 X 0.3 = 3.6"
EXIT WIDTH PROVIDED = 36" > 3.6" = **OKAY**

LEVEL 4:
12 OCCUPANTS EXITING
EXIT WIDTH REQUIRED = 12 X 0.3 = 3.6"
EXIT WIDTH PROVIDED = 36" > 3.6" = **OKAY**

EXIT SIGNS - PER CBC 1013.1:
EXIT SIGNS ARE NOT REQUIRED IN ROOMS OR AREAS THAT REQUIRES ONLY ONE EXIT OR EXIT ACCESS.

GROUP R-2:
LEVEL 2: REQUIRED EXIT = 2= **OKAY**
LEVEL 3: REQUIRED EXIT = 2= **OKAY**
LEVEL 4: REQUIRED EXIT = 2= **OKAY**

CORRIDORS - PER CBC 1020.1:

CORRIDORS SHALL BE FIRE-RESISTANCE RATED IN ACCORDANCE WITH TABLE 1020.1
EXCEPTION:
• A FIRE RESISTANCE RATING IS NOT REQUIRED FOR CORRIDORS WITHIN OPEN PARKING SPACES.
• A FIRE RESISTANCE RATING IS NOT REQUIRED FOR CORRIDORS CONTAINING WITHIN A DWELLING UNIT IN AN OCCUPANCY GROUP R.
• CORRIDORS ADJACENT TO THE EXTERIOR WALL OF THE BUILDINGS SHALL BE PERMITTED TO HAVE UNPROTECTED OPENING ON UNRATED EXTERIOR WALLS WHERE UNRATED WALLS ARE PERMITTED PER TABLE 602 AND UNPROTECTED OPENINGS ARE PERMITTED BY TABLE 705.8.

OCCUPANCY	OCCUPANT LOAD SERVED BY CORRIDOR	REQUIRED FIRE-RESISTANCERATING	
		WITHOUT SPRINKLER SYSTEM	WITH SPRINKLER SYSTEM
A, B, S	GREATER THAN 30	1	0
R-2	GREATER THAN 10	1	1

CORRIDOR FIRE RESISTANCE RATING ANALYSIS:

LEVEL 4:
GROUP R-2: 12 OCC. > 10 OCC. = **REQUIRED 1 HOUR RATING**

LEVEL 3:
GROUP R-2: 12 OCC. > 10 OCC. = **REQUIRED 1 HOUR RATING**

LEVEL 2:
GROUP R-2: 14 OCC. > 10 OCC. = **REQUIRED 1 HOUR RATING**

MINIMUM CORRIDOR WIDTH - PER CBC TABLE 1020.2:

OCCUPANCY	MINIMUM WIDTH (INCHES)
WITHIN A DWELLING UNIT	36

CORRIDOR WIDTH LEVEL 2,3 & 4 = 102" > 36" = **OKAY**

LEGEND, OCCUPANT LOAD FACTOR

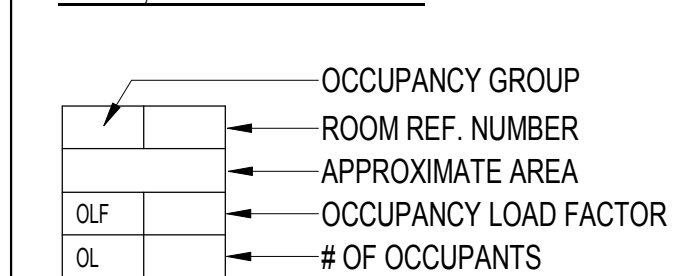

EXIT WIDTH REQUIRED OTHER THAN STAIRWAYS

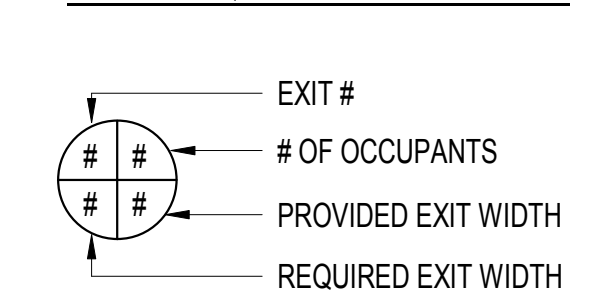

COMMON PATH OF EGRESS TRAVEL LEGEND

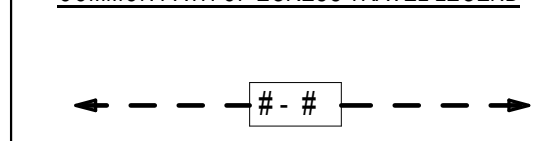

Occupancy & Egress Analysis, Levels 2-4

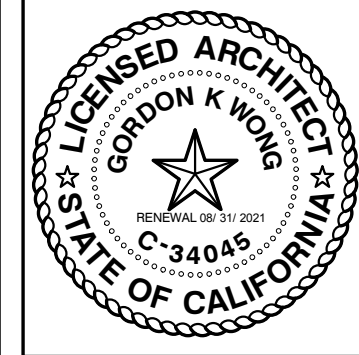

WENJIA JIA, JENNY C WONG & DANIA BAHARRAL, DESIGNER
 GKW ARCHITECTS, INC.
 710 E BUCKINGHAM LANE, SUITE 108, CAMPBELL, CA 95008
 (408) 783-1845 | WWW.GKWARCHITECTS.COM

GKW ARCHITECTS, INC.
 710 E BUCKINGHAM LANE, SUITE 108, CAMPBELL, CA 95008
 (408) 783-1845 | WWW.GKWARCHITECTS.COM

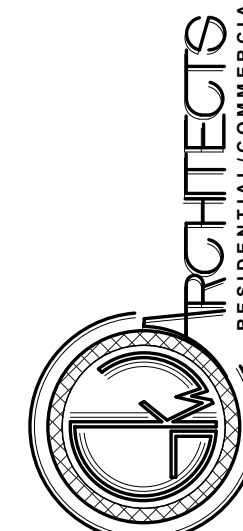

**396 Third Ave
 Mixed-Use Development**

396 Third Ave., Redwood City, CA 94063

Site Plan, Existing & Proposed

Rev. #	Date	Description
1	2019.10.31	Planning, Geo., PW
2	2019.10.31	File
3	2020.02.05	File

Site Plan, Existing & Proposed

A100

SCALE 1" = 10'-0"

2/6/2020 9:57:59 AM

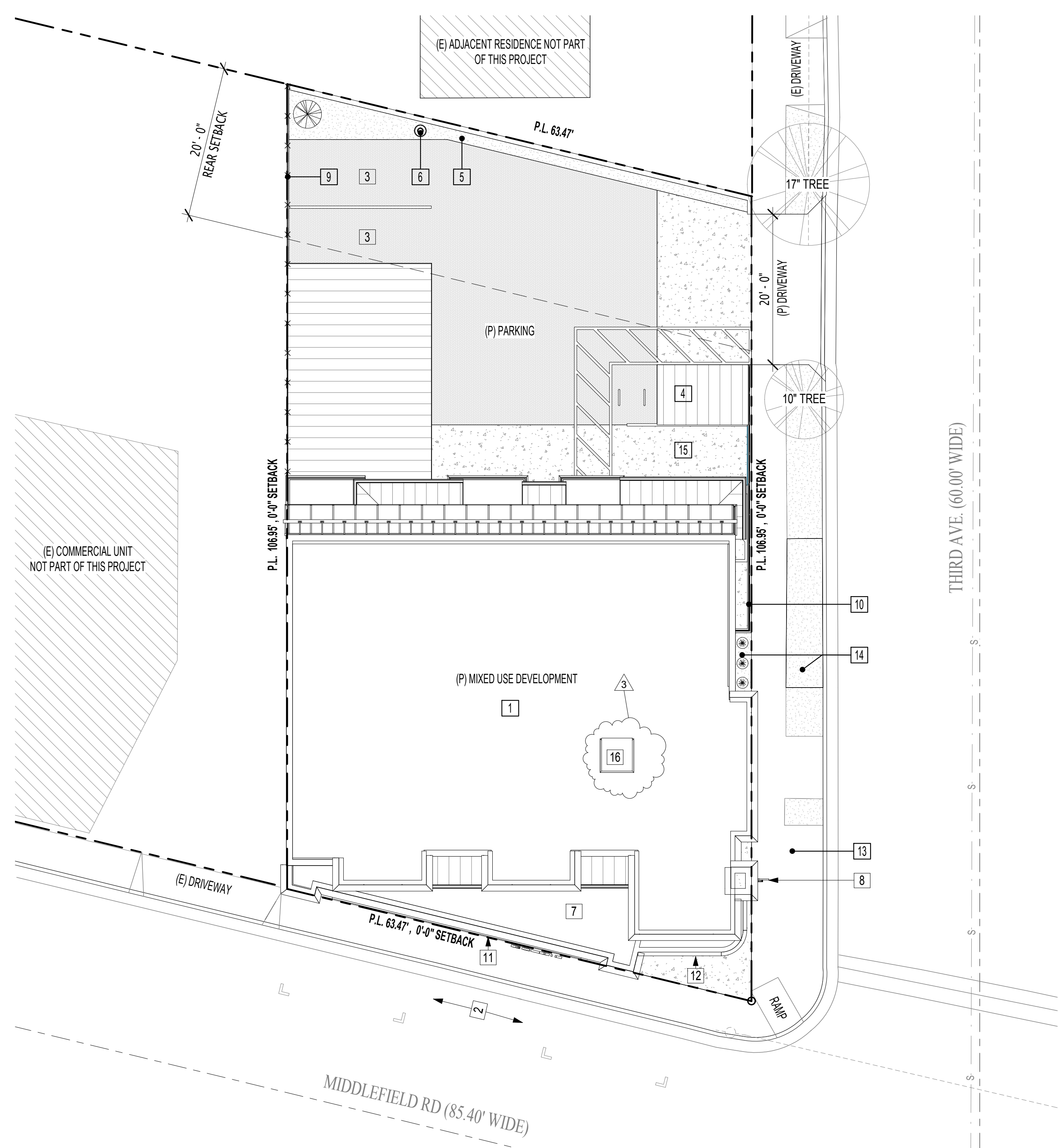

PROPOSED SITE PLAN KEYNOTES:

- 1 NEW CONSTRUCTION MIXED USE BUILDING. SEE SHEET A000 FOR LOT COVERAGE CALCULATIONS AND A003 FOR F.A.R. ANALYSIS.
- 2 (E) STREET PARKING TO REMAIN
- 3 PARKING 9'x19'
- 4 TRASH ENCLOSURE
- 5 LANDSCAPE AREA
- 6 LIGHT POST
- 7 BALCONY
- 8 SIGN (BUILDING NUMBER)
- 9 FENCE 7 FEET HIGH
- 10 PARKING WALL, 7 FEET HIGH.
- 11 COMMERCIAL MAIN ENTRY
- 12 RESIDENTIAL MAIN ENTRY
- 13 SIDE WALK
- 14 STREET LANDSCAPE
- 15 COMPACT PARKING 8'x16'
- 16 ROOF ACCESS, 4'x4'

SITE PLAN LEGEND:

- — — — — PROPERTY LINE
- — — — — SETBACK LINE
- - - - - E(O.H.) - - - - - EXISTING ELECTRIC OVERHEAD
- x - x - x - PROPOSED FENCE
- s - s - s - EXISTING SANITARY SEWER LINE
- - - - - ROAD CENTER LINE
- [Pattern] CONCRETE
- [Pattern] PERMEABLE PAVERS

NOTES:

1. INFORMATION ON THIS SHEET IS FOR GENERAL INFORMATION ONLY, AND SHALL NOT BE USED FOR LAYOUT OF THE SITE. REFER TO THE CIVIL PLANS FOR PRECISE LOCATION OF STRUCTURES, CURBS, PAVING, ETC., FOR LAYOUT OF WORK IN ACCORDANCE WITH CIVIL DRAWINGS.
2. PUBLIC USE AND COMMON USE AREAS SHALL BE ACCESSIBLE. REFER TO CIVIL PLANS.
3. REFER TO CIVIL PLANS FOR INTERIOR LOT LINES, DESIGNATED FLOOD PLANS, OPEN SPACE EASEMENTS OR OTHER DEVELOPMENT RESTRICTED AREA.
4. REFER TO CIVIL PLANS FOR PARKING SPACES AND SIDEWALK DIMENSIONS AND SPECIFICATIONS.
5. ALL OVERHEAD POWER LINES FRONTING THE BUILDING ON MIDDLEFIELD AND THIRD AVE SHALL BE REROUTED UNDERGROUND.

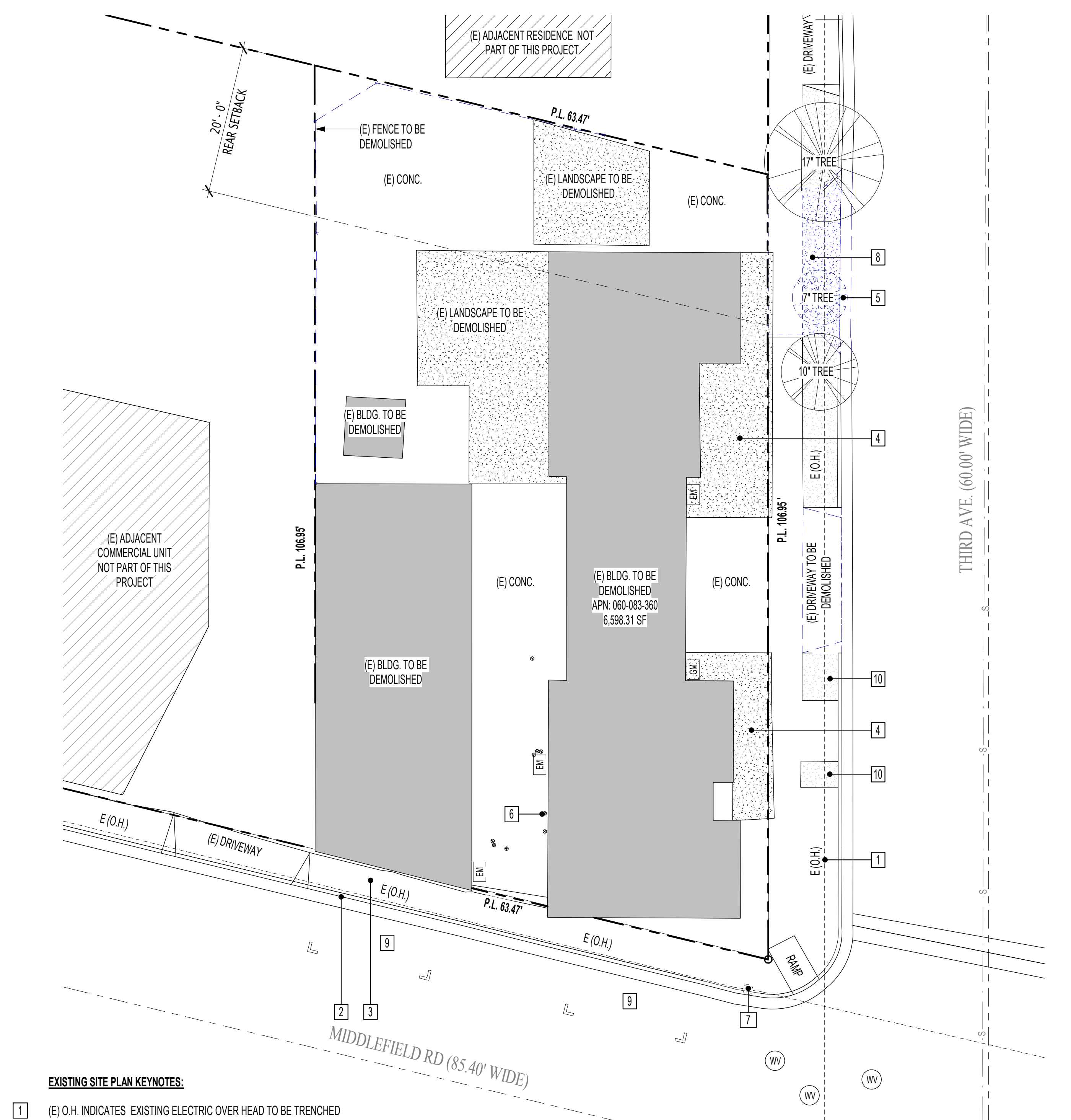
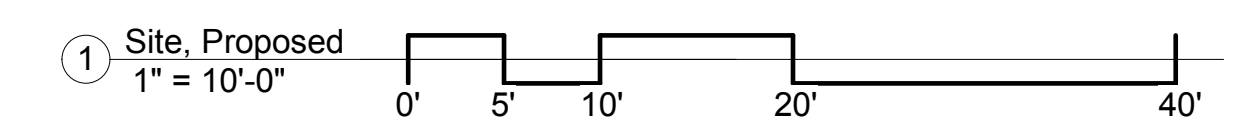

EXISTING SITE PLAN KEYNOTES:

- 1 (E) O.H. INDICATES EXISTING ELECTRIC OVER HEAD TO BE TRENCHED UNDERGROUND
- 2 (E) CURB AND GUTTER
- 3 (E) SIDEWALK
- 4 (E) LANDSCAPE TO BE DEMOLISHED
- 5 (E) TREE TO BE DEMOLISHED
- 6 (E) BILLBOARD, TYP.
- 7 (E) POWER POLE TO BE REMOVED
- 8 (E) LANDSCAPE TO BE MODIFIED SEE PROPOSED SITE PLAN
- 9 (E) STREET PARKING
- 10 (E) STREET LANDSCAPE

SITE PLAN LEGEND:

- — — — — PROPERTY LINE
- - - - - SETBACK LINE
- - - - - EXISTING ELECTRIC OVERHEAD
- - - - - EXISTING FENCE
- - - - - EXISTING FLOW LINE
- s - s - s - SANITARY SEWER LINE
- - - - - ROAD CENTER LINE
- [GM] GAS METER
- [EM] ELECTRIC METER
- [WV] WATER VALVE

NOTES:

1. INFORMATION ON THIS SHEET IS FOR GENERAL INFORMATION ONLY. REFER TO CIVIL PLANS FOR MORE INFORMATION.

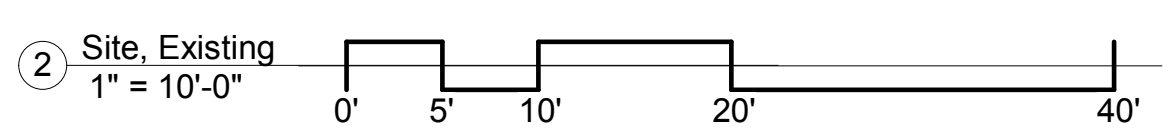

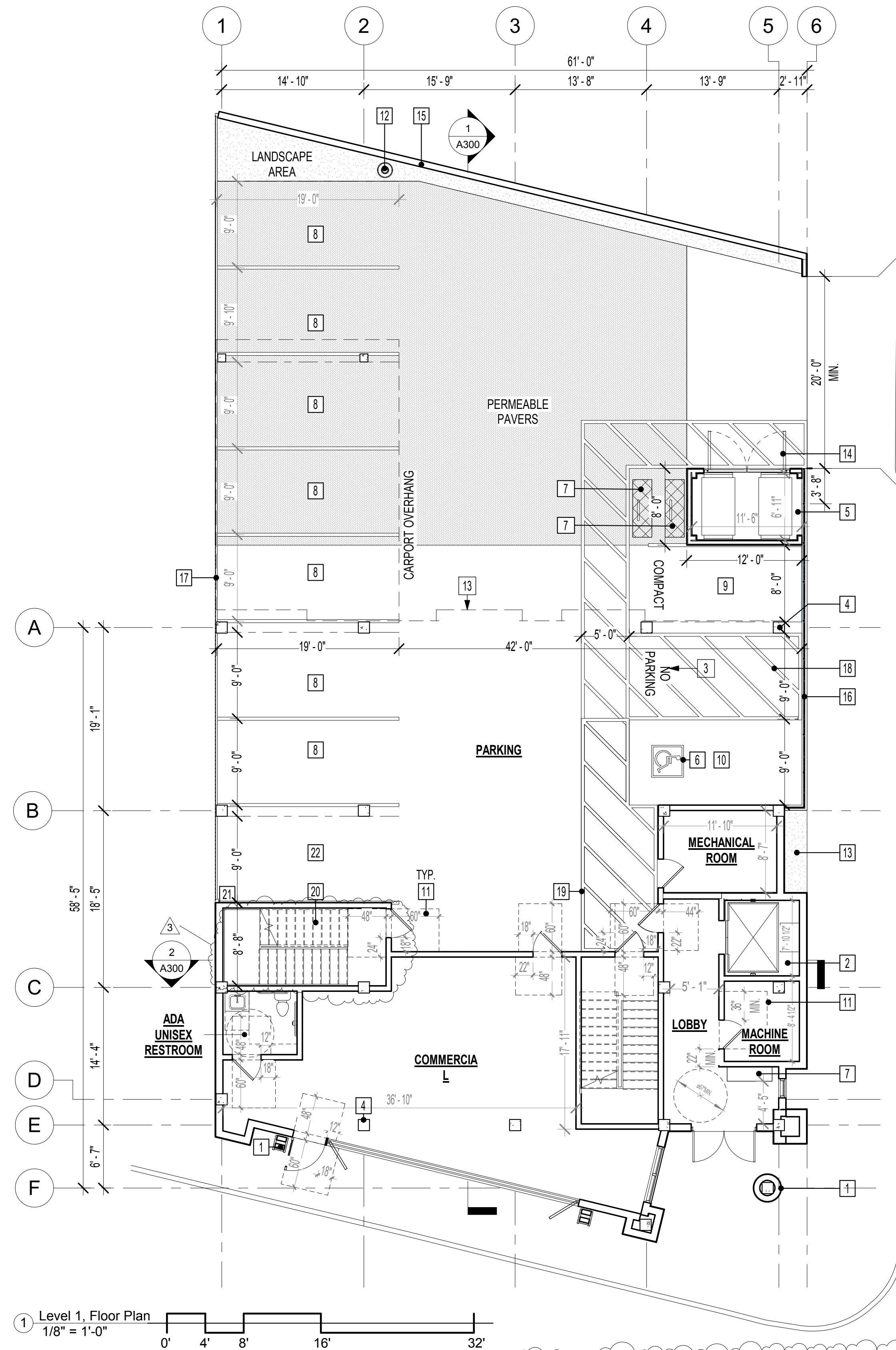

① Level 1, Floor Plan
1/8" = 1'-0"

REVIEWED
By William Saxton at 6:35 am, May 05, 2020

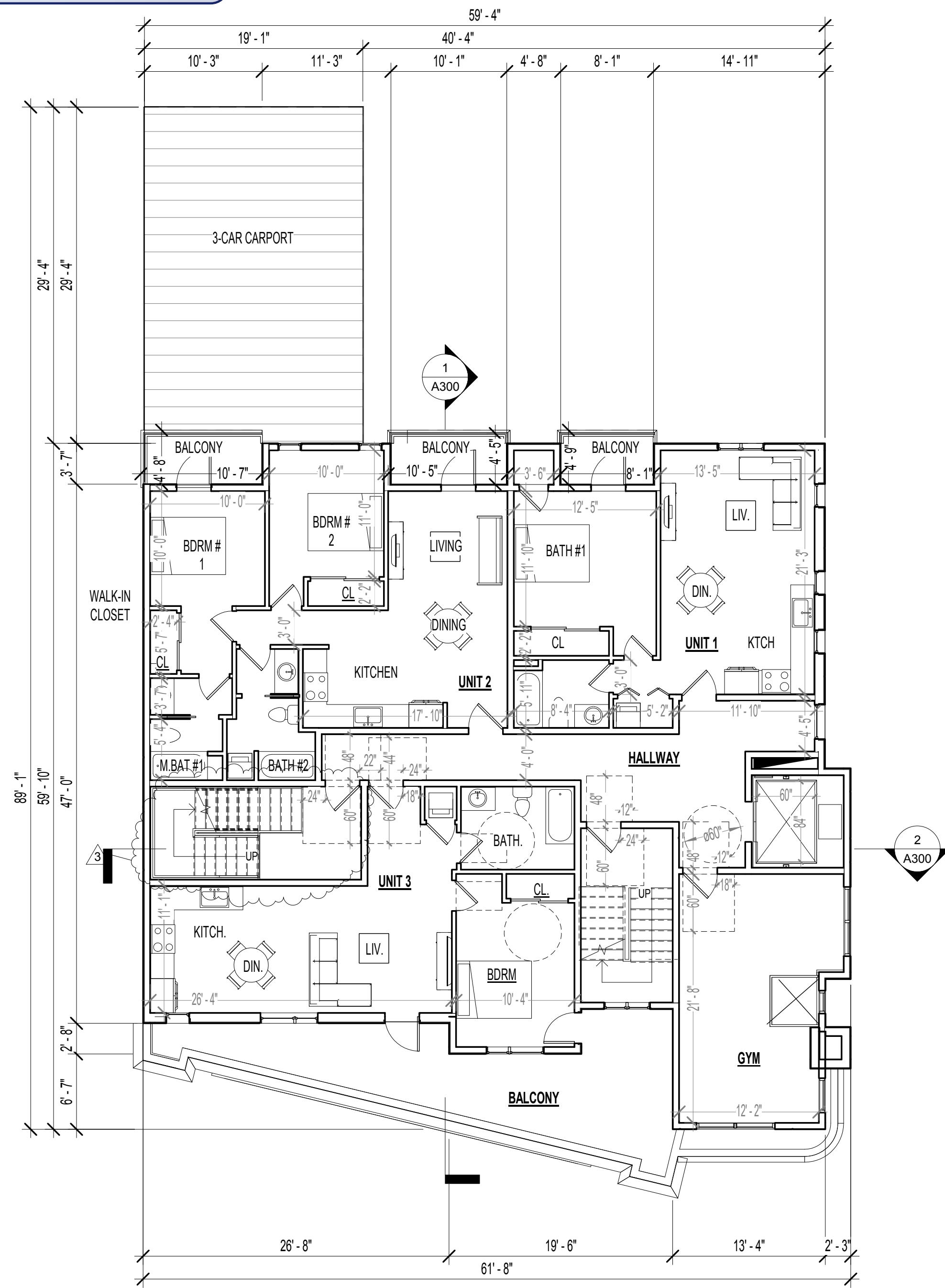

② Level 2, Floor Plan
1/8" = 1'-0"

LEVEL 1 KEYNOTES:

1 DECORATIVE COLUMNS	8 STANDARD PARKING 9' X 19'	15 7'-0" HIGH CMU WALL
2 ELEVATOR	9 COMPACT PARKING 8' X 16'	16 7'-0" HIGH 2X4 WALL
3 WHITE LETTERING 12"	10 VAN ACCESSIBLE PARKING	17 7'-0" HIGH WOOD FENCE
4 COLUMN, TYP. S.S.D	11 ADA CLEARANCE, MINIMUM	18 ACCESS AISLE
5 TRASH ENCLOSURE	12 LIGHT POST	19 ACCESS AISLE, 5'-0" WIDE
6 INTERNATIONAL SYMBOL OF ACCESSIBILITY 3' X 3'	13 BUILDING OUTLINE	20 BICYCLE PARKING
7 RESIDENTIAL MAILBOXES	14 9' W X 7' H GATE	21 EV CHARGER
		22 CLEAN AIR VEHICLE PARKING

FLOOR PLAN ANALYSIS - LEVEL 1

AREA	AREA (SF)	STORAGE / UTILITY	BATH (#)
PARKING	4,369	1	-
COMMERCIAL	848	1	1
LOBBY	643	1	-
MECHANICAL	283	1	-

LEVEL 1 NOTES:

- ALL CEILING HEIGHTS PER SECTION AND ELEVATION P.L.T. HTS. U.N.O.

FLOOR PLAN NOTES:

- ALL CEILING HEIGHTS PER SECTION AND ELEVATION P.L.T. HTS. U.N.O.
- U.N.O. DOORS TO BE 6'-8" TALL STANDARD.

GENERAL PLAN NOTES

- ALL CEILING HTS. PER SECTION AND ELEVATION P.L.T. HTS. U.N.O. WINDOW SILL HEIGHTS WHERE OPENING OF THE OPERABLE WINDOW IS LOCATED MORE THAN 72 INCHES ABOVE THE FINISHED GRADE OR SURFACE BELOW, THE LOWEST PART OF THE CLEAR OPENING OF THE WINDOW SHALL BE A MIN. 24 INCHES ABOVE THE FINISHED FLOOR OF THE ROOM IT IS LOCATED. (C.R.C R612.2)
- ALL EXTERIOR SWINGING DOORS SHALL BE OF SOLID CORE CONSTRUCTION WITH A MINIMUM THICKNESS OF 1 3/4 INCHES OR WITH PANELS NOT LESS THAN 9/16 INCHES THICK. OPENINGS BETWEEN GARAGE AND RESIDENCE SHALL BE SOLID WOOD DOORS NOT LESS THAN 1 3/4 INCHES IN THICKNESS. SOLID OR HONEYCOMB CORE STEEL DOORS NOT LESS THAN 1 3/4 INCHES IN THICK, OR 20 MINUTE FIRE RATED DOORS. DOORS SHALL BE SELF-CLOSING AND SELF LATCHING (C.R.C R 302.5.1)
- EXCEPTION: RESIDENCE & PRIVATE GARAGES ARE PROTECTED BY AN AUTOMATIC RESIDENTIAL FIRE SPRINKLER SYSTEM IN ACCORDANCE WITH SEC. R309.6 AND R313 DOOR OPENINGS BETWEEN PRIVATE GARAGE & THE RESIDENCE NEED ONLY BE SELF-CLOSING & SELF LATCHING.
- ALL INTERIOR DOORS TO BE HOLLOW CORE, 1 3/8" THICK, U.N.O. (REFER TO PLAN FOR SIZE) DOORS TO BE 6'-8" TALL STANDARD.
- ALL FLOOR MATERIAL CHANGES TO OCCUR AT CENTER OF DOOR JAMBS.
- SEE CF-IR FORM, SHEET T 24 FOR ANY SPECIAL GLAZING OR SHADING REQUIREMENTS.

FLOOR PLAN ANALYSIS - LEVEL 2

	LIVING (SF)	BALCONY (SF)	TOTAL (SF)	BDRM (#)	BATH (#)
UNIT 1	622	37	659	1	1
UNIT 2	800	96	896	2	2
UNIT 3	657	304	961	1	1
GYM	295	-	295	-	-

STAIR NOTES

- RISER = 7", TREAD = 10" U.O.N.
- HANDRAIL AT WALL 36" ABOVE TREAD NOSING PER CBC 1009.15 & CRC R311.7.8
- ALL WALLS AND SOFFITS OF ENCLOSED USABLE SPACE UNDER INTERIOR SAIRWAYS SHALL BE PROTECTED ON THE ENCLOSED SIDE WITH A MINIMUM OF 1/2" GYPSUM BOARD PER CRC R302.7

ELEVATOR NOTES, ELEVATOR CAR DIMENSIONS FOR CENTER DOOR LOCATION PER CBC TABLE AAB-407.4.1

- CLEAR DOOR WIDTH: 42 INCHES
- INSIDE CAR, SIDE TO SIDE: 80 INCHES
- INSIDE CAR, BACK WALL TO FRONT RETURN: 51 INCHES
- INSIDE CAR, BACK WALL TO INSIDE FACE OF DOOR: 54 INCHES

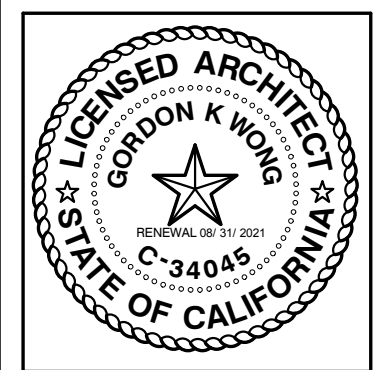

WEIRAN JIA, JENNY C WONG & DANIA BAHARRA, DESIGNER
GKW ARCHITECTS, INC.
710 S MCCLINTOCK LANE, SUITE 100, CAMPBELL, CA 95008
(408) 783-0481 | WWW.GKWARCHITECTS.COM

GKW ARCHITECTS, INC.
710 S MCCLINTOCK LANE, SUITE 100, CAMPBELL, CA 95008
(408) 783-0481 | WWW.GKWARCHITECTS.COM

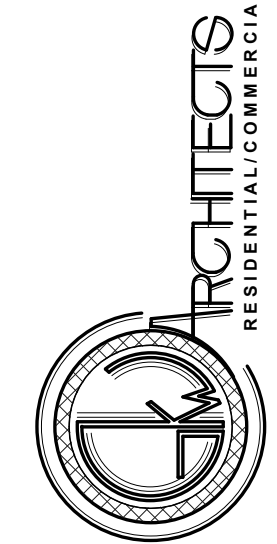

Level 1 & 2 Plans, Proposed

396 Third Ave
Mixed-Use Development
396 Third Ave., Redwood City, CA 94063

Project Schedule Revision

Rev. #	Date	Description
1	2019.10.31	Planning, Geo., PW
2	2019.10.31	File
3	2020.02.05	File

Level 1 & 2 Plans, Proposed

A101

SCALE 1/8" = 1'-0"

2/6/2020 9:58:05 AM



WEIRAN JIA, JENNY C WONG & DANIA BAHABIRAL, DESIGNER
 GKW ARCHITECTS, INC.
 710 E MCJANNET LANE, SUITE 108, CAMPBELL, CA 95008
 (408) 783-0481 WWW.GKWARCHITECTS.COM

GKW ARCHITECTS, INC.
 710 E MCJANNET LANE, SUITE 108, CAMPBELL, CA 95008
 (408) 783-0481 WWW.GKWARCHITECTS.COM

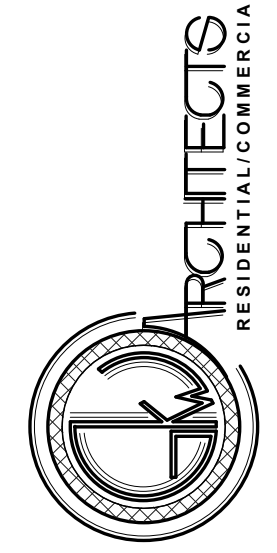

396 Third Ave
Mixed-Use Development
 396 Third Ave., Redwood City, CA 94063

Level 3 & 4 Plans, Proposed

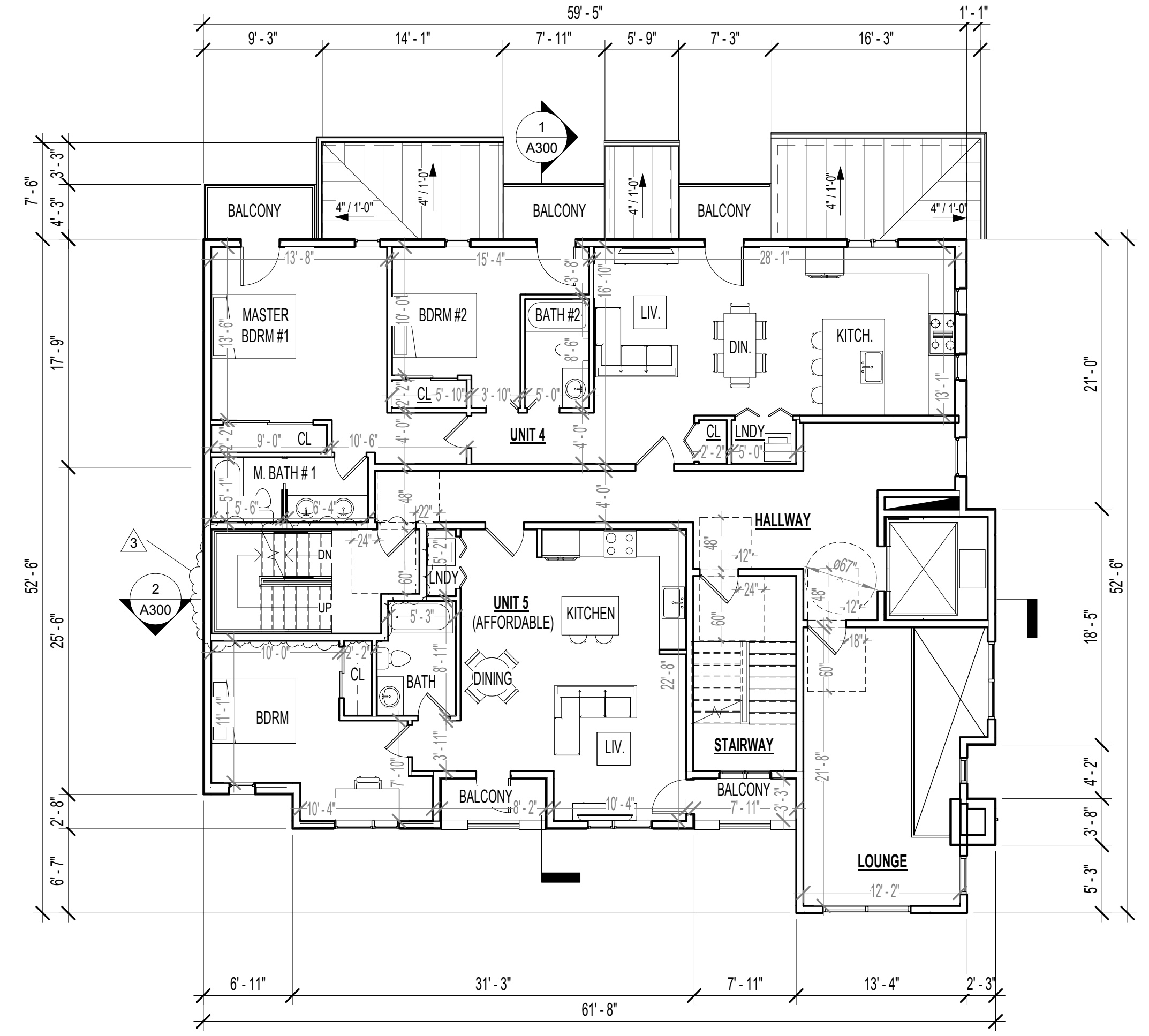

1 Level 3, Floor Plan
 1/8" = 1'-0"

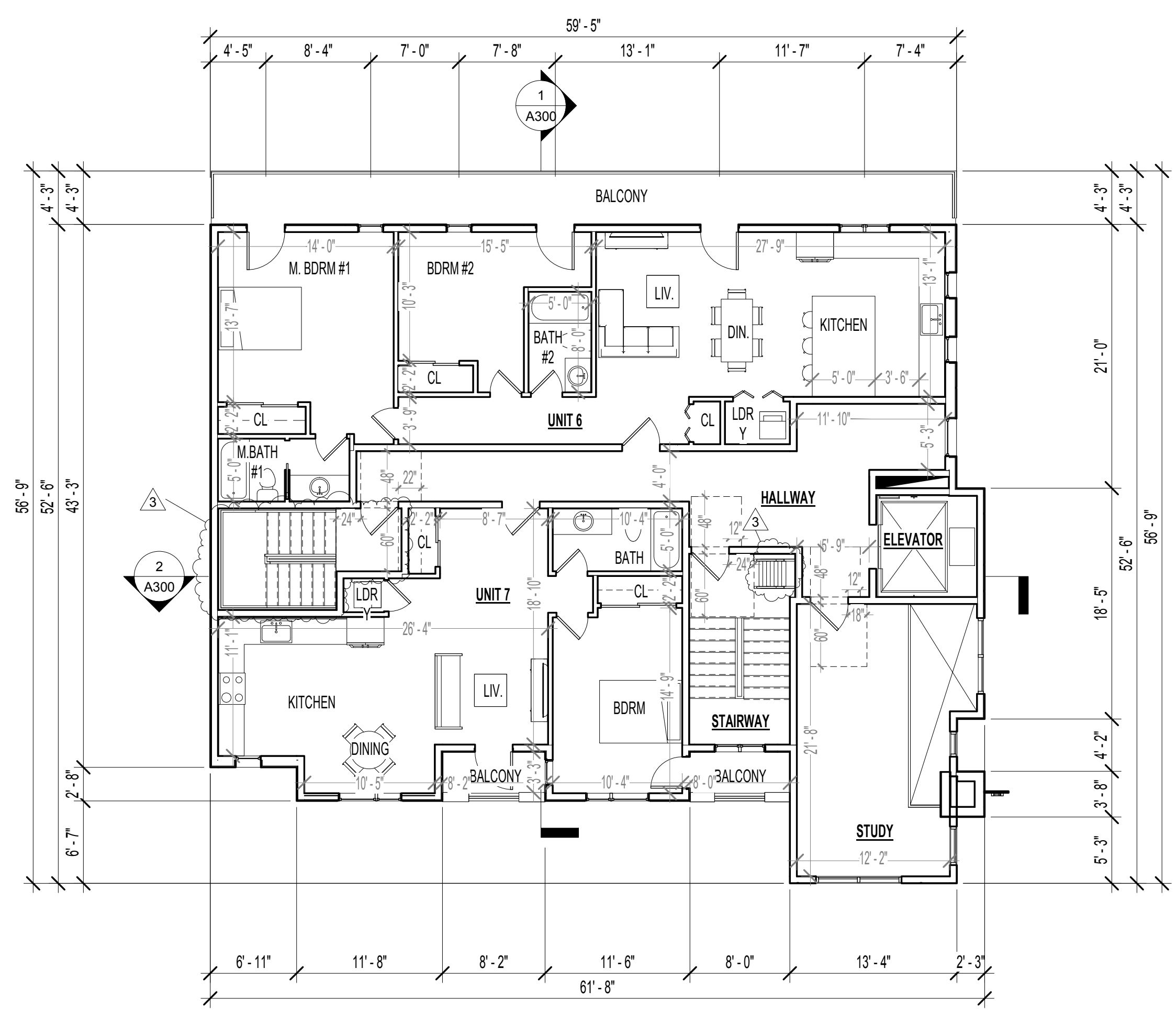

2 Level 4, Floor Plan
 1/8" = 1'-0"

GENERAL PLAN NOTES

- ALL CEILINGS HTS. PER SECTION AND ELEVATION PLT. HTS. U.N.O. WINDOW SILL HEIGHTS WHERE OPENING OF THE OPERABLE WINDOW IS LOCATED MORE THAN 72 INCHES ABOVE THE FINISHED GRADE OR SURFACE BELOW. THE LOWEST PART OF THE CLEAR OPENING OF THE WINDOW SHALL BE A MIN. 24 INCHES ABOVE THE FINISHED FLOOR OF THE ROOM IT IS LOCATED. (C.R.C R612.2)
- ALL EXTERIOR SWINGING DOORS SHALL BE OF SOLID CORE CONSTRUCTION WITH A MINIMUM THICKNESS OF 1 3/4 INCHES OR WITH PANELS NOT LESS THAN 9/16 INCHES THICK. OPENINGS BETWEEN GARAGE AND RESIDENCE SHALL BE SOLID WOOD DOORS NOT LESS THAN 1 3/4 INCHES IN THICKNESS. SOLID OR HONEYCOMB CORE STEEL DOORS NOT LESS THAN 1 3/4 INCHES IN THICK, OR 20 MINUTE FIRE RATED DOORS. DOORS SHALL BE SELF-CLOSING AND SELF LATCHING (C.R.C R 302.5.1)
- EXCEPTION: RESIDENCE & PRIVATE GARAGES ARE PROTECTED BY AN AUTOMATIC RESIDENTIAL FIRE SPRINKLER SYSTEM IN ACCORDANCE WITH SEC. R309.6 AND R313 DOOR OPENINGS BETWEEN PRIVATE GARAGE & THE RESIDENCE NEED ONLY BE SELF-CLOSING & SELF LATCHING.
- ALL INTERIOR DOORS TO BE HOLLOW CORE, 1 3/8" THICK, U.O.N. DOORS TO BE 6'-8" TALL STANDARD.
- ALL FLOOR MATERIAL CHANGES TO OCCUR AT CENTER OF DOOR JAMBS.

FLOOR PLAN ANALYSIS - LEVEL 3

	LIVING (SF)	BALCONY (SF)	TOTAL (SF)	BDRM (#)	BATH (#)
UNIT 4	1,068	111	1,179	2	2
UNIT 5	706	63	779	1	1
LOUNGE	229	-	229	-	-

STAIR NOTES

- RISER = 7", TREAD = 10" U.O.N.
- HANDRAIL AT WALL 36" ABOVE TREAD NOSING PER CBC 1009.15 & CRC R311.7.8
- ALL WALLS AND SOFFITS OF ENCLOSED USABLE SPACE UNDER INTERIOR SAIRWAYS SHALL BE PROTECTED ON THE ENCLOSED SIDE WITH A MINIMUM OF 1/2" GYPSUM BOARD PER CRC R302.7

ELEVATOR NOTES, ELEVATOR CAR DIMENSIONS FOR CENTER DOOR LOCATION PER CBC TABLE AAB-407.4.1

- CLEAR DOOR WIDTH: 42 INCHES
- INSIDE CAR, SIDE TO SIDE: 80 INCHES
- INSIDE CAR, BACK WALL TO FRONT RETURN: 51 INCHES
- INSIDE CAR, BACK WALL TO INSIDE FACE OF DOOR: 54 INCHES

GLAZING NOTES PER CRC R308

- ALL GLAZING IS DUAL PANE INSULATING GLASS GLAZING AND WET SURFACES. GLAZING IN WALLS, ENCLOSURES OR FENCES CONTAINING HOT TUBS, SPAS, SHIRLPOOLS, SAUNAS, STEAM ROOMS, BATHTUBS, SHOWERS AND INDOOR OR OUTDOOR SWIMMING POOLS WHERE THE BOTTOM EXPOSED EDGE OF THE GLAZING IS LESS THAN 60 INCHES MEASURED VERTICALLY ABOVE ANY STANDING OR WALKING SURFACE SHALL BE CONSIDERED TO BE A HAZARDOUS LOCATION. THIS SHALL APPLY TO SINGLE GLAZING AND EACH PANE IN MULTIPLE GLAZING. EXCEPTION: GLAZING THAT IS MORE THAN 60 INCHES MEASURED HORIZONTALLY AND IN A STRAIGHT LINE, FROM THE WATER'S EDGE OF A BATHRUB, HOT TUB, SPA, WHIRLPOOL OR SWIMMING POOL OR FROM THE EDGE OF A SHOWER, SAUNA OR STEAM ROOM. PER CRC R308.4.5
- GLAZING IN GAURDS AND RAILINGS. GLAZING IN GUARDS AND RAILINGS, INCLUDING STRUCTURAL BALUSTER PANELS AND NONSTRUCTURAL INFILL PANELS, REGARDLESS OF AREA OR HEIGHT ABOVE A WALKING SURFACE SHALL BE CONSIDERED TO BE A HAZARDOUS LOCATION. PER CRC R308.4.4
- GLAZING IN AN INDIVIDUAL OR OPERABLE PANEL THAT MEETS ALL OF THE FOLLOWING CONDITIONS SHALL BE CONSIDERED TO BE A HAZARDOUS LOCATION:
 - THE EXPOSED AREA OF AN INDIVIDUAL PANE IS LARGER THAN 9 SF
 - THE BOTTOM EDGE OF THE GLAZING IS LESS THAN 18 INCHES ABOVE THE FLOOR
 - THE TOP EDGE OF THE GLAZING IS MORE THAN 36 INCHES ABOVE THE FLOOR; AND
 - ONE OR MORE OF THE WALK'S SURFACES ARE WITHIN 36 INCHES, MEASURED HORIZONTALLY AND IN A STRAIGHT LINE OF THE GLAZING

FLOOR PLAN ANALYSIS - LEVEL 4

	AREA (SF)	BALCONY (SF)	TOTAL (SF)	BDRM (#)	BATH (#)
UNIT 6	1,061	253	1,314	2	2
UNIT 7	726	63	789	1	1
STUDY	236	-	236	-	-

STAIRWAYS PER CBC 1011

- WIDTH AND CAPACITY. THE REQUIRED CAPACITY OF STAIRWAYS SHALL BE DETERMINED IN SECTION 1005.1 BUT THE MINIMUM WIDTH SHALL NOT BE LESS THAN 44 INCHES.

CORRIDORS PER CBC 1020

- CORRIDORS SHALL BE FIRE RESISTANCE RATED IN ACCORDANCE WITH TABLE 1020.1. THE CORRIDOR WALLS REQUIRED TO BE FIRE-RESISTANCE RATED SHALL COMPLY WITH SECTION 708 FOR FIRE PARTITIONS.

Project Schedule Revision

Rev. #	Date	Description
1	2019.10.31	Planning, Geo., PW
2	2019.10.31	File
3	2020.02.05	File

Level 3 & 4 Plans, Proposed

A102

SCALE 1/8" = 1'-0"

2/6/2020 9:58:07 AM



WERRAN JIA, JENNY C WONG & DANNA BAHARRAM, DESIGNER
 GKW ARCHITECTS, INC.
 710 E MCJANNET LANE SUITE 108, CAMPBELL, CA 95008
 (408) 784-1841 | WWW.GKWARCHITECTS.COM

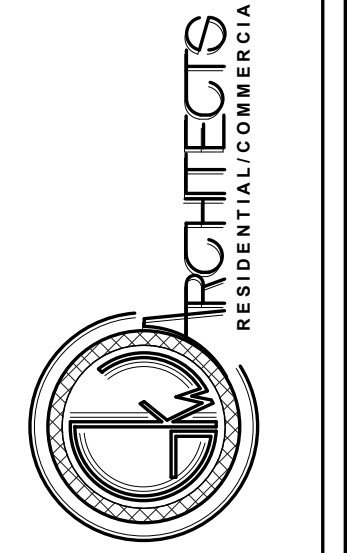

**396 Third Ave
 Mixed-Use Development**
 396 Third Ave., Redwood City, CA 94063

Project Schedule Revision		
Rev. #	Date	Description
1	2019.10.31	Planning, Geo., PW
2	2019.10.31	File
3	2020.02.05	File

Roof Plan, Proposed

A103

SCALE 1/8" = 1'-0"

2/6/2020 9:58:09 AM

Roof Plan, Proposed

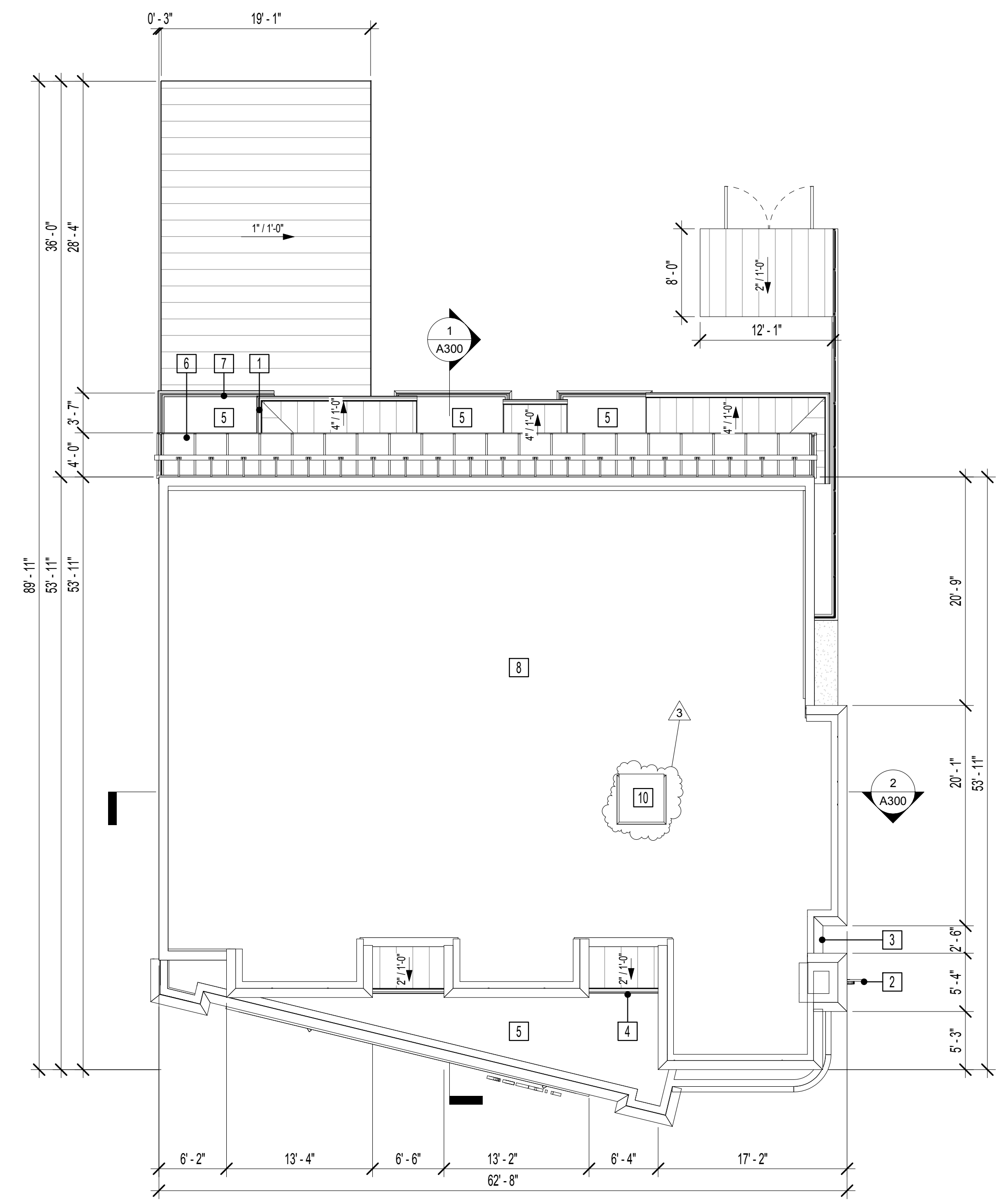

- KEYNOTES**
- 1 STANDING SEAM METAL ROOF
 - 2 BUILDING SIGNAGE
 - 3 CORNICE
 - 4 GUTTER
 - 5 BALCONY
 - 6 TRELLIS
 - 7 RAILING
 - 8 ROOF 1% SLOPE
 - 10 ROOF ACCESS, 4'X4' 16 SF OPENING
- NOTES**
- 1. GENERAL CONTRACTOR AND OWNER TO VERIFY ALL DIMENSIONS AND DESIGNS ON SITE

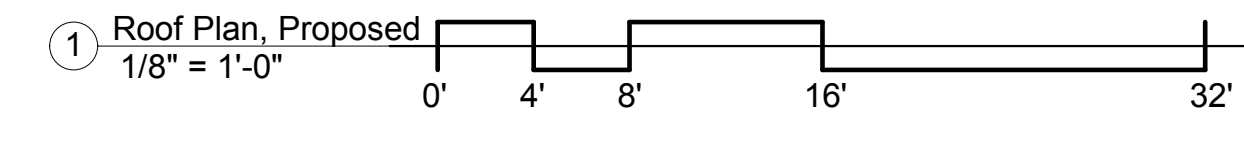

REVIEWED

By William Saxton at 6:35 am, May 05, 2020

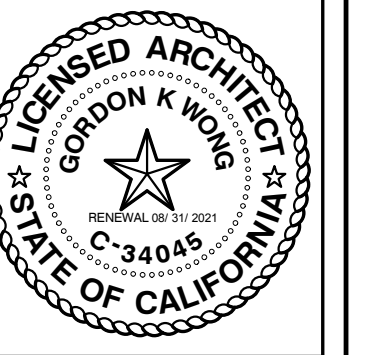

WIERAN JIA, JENNY C WONG & DANNA BAHARRAL, DESIGNER
 GKW ARCHITECTS, INC.
 710 S MCCLINTOCK LANE, SUITE 108, CAMPBELL, CA 95008
 (408) 783-1845 | WWW.GKWARCHITECTS.COM

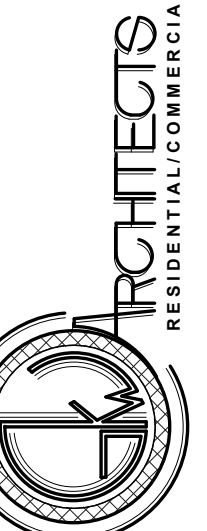

396 Third Ave
Mixed-Use Development
 396 Third Ave., Redwood City, CA 94063

Rev. #	Date	Description
1	2019.10.31	Planning, Geo., PW
2	2019.10.31	File
3	2020.02.05	File

Elevations Material

A200

SCALE 1/8" = 1'-0"

2/6/2020 9:58:27 AM



3 North Elevation, Proposed
 1/8" = 1'-0"

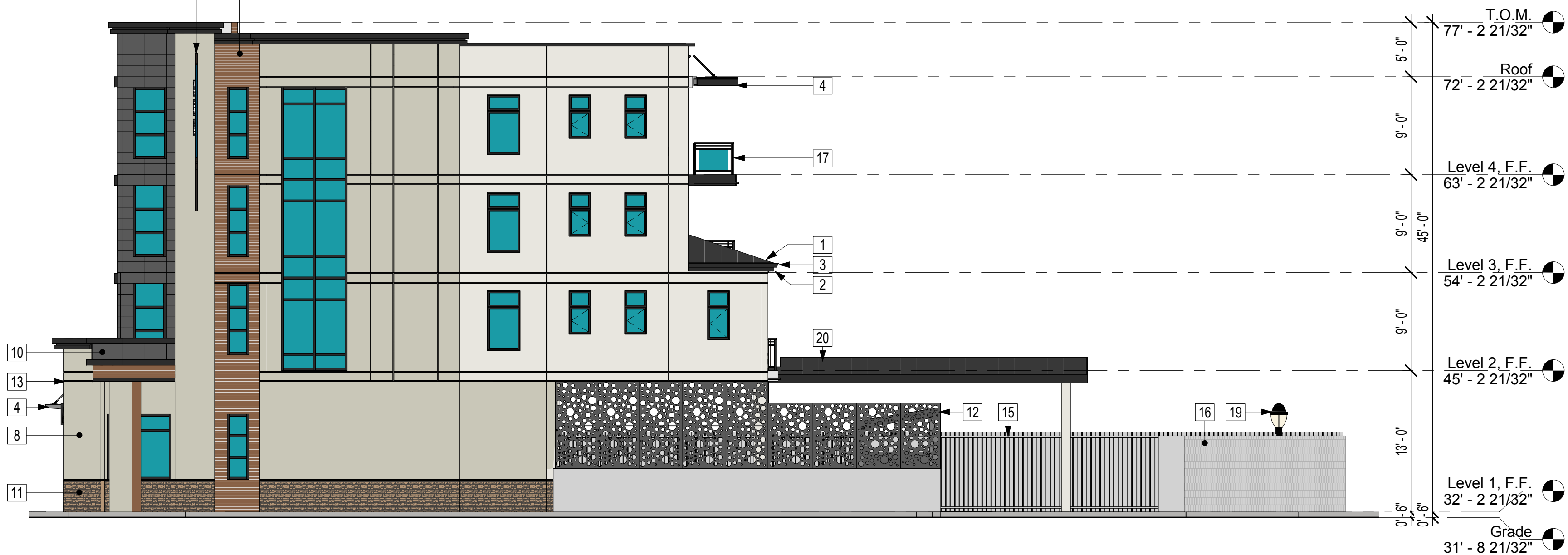

2 West Elevation, Proposed
 1/8" = 1'-0"



1 South Elevation, Proposed
 1/8" = 1'-0"

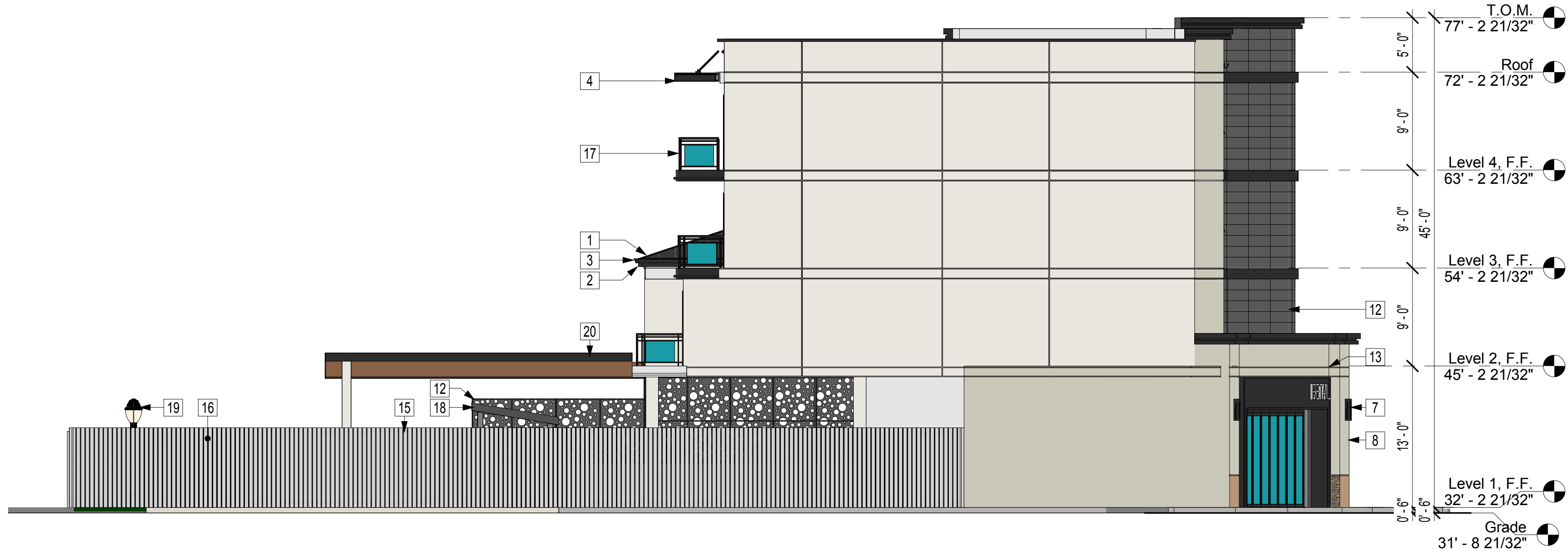

4 East Elevation, Proposed
 1/8" = 1'-0"

Elevations Material

Exterior Wall & Roof Materials

TRIMS & TREATMENTS	WALL			ROOF		
REVEAL SYSTEM LAHABRA STUCCO COLOR: MESA VERDE 215 (48) / BASE 200	UPPER LAHABRA STUCCO COLOR: MESA VERDE 215 (48) / BASE 200	UPPER LAHABRA STUCCO COLOR: DOVE GREY 40 (66) / BASE 200	ACCENT LAMBOO ELEMENTS COLOR: VERTICAL FAWN	ACCENT CITADEL ARCHITECTURAL PRODUCTS SERIES: ENVELOPE 2000 COMPOSITION: PRE-FIN. ALUM. FACE	BASE ACCENT CULTURED STONE STYLE: COUNTRY LEDGESTONE COLOR: GRAND MESA	BASE ACCENT HENDRICK ARCHITECTURAL PERFORATED METAL CLADDING COLOR: SLATE GREY

Exterior Elevation Keynotes

- | | | |
|----------------------------|--------------------------------|---------------------------|
| 1 STANDING SEAM METAL ROOF | 8 STUCCO | 15 WOOD FENCE, 72" HEIGHT |
| 2 FASCIA | 9 LAMBOO EXTERIOR, ACCENT | 16 CMU WALL, 72" HEIGHT |
| 3 GUTTER | 10 ALUMINUM CLADDING, ACCENT | 17 RAILING |
| 4 TRELLIS | 11 CULTURED STONE, BASE ACCENT | 18 GARBAGE ENCLOSURE |
| 5 DECORATIVE SIGNAGE | 12 PERFORATED METAL CLADDING | 19 LIGHT POST |
| 6 BUILDING SIGNAGE | 13 STUCCO REVEAL LINE | 20 3-CAR CARPORT |
| 7 EXTERIOR LIGHTING | 14 CONCRETE COLUMN, 14" X 14" | |



WEIRAN JIA, JENNY C WONG & DANNA BAHARRAL, DESIGNER
 GW ARCHITECTS, INC.
 710 S MCCLINTOCK LANE, SUITE 100, CAMPBELL, CA 95008
 (408) 783-1481 WWW.GWARCHITECTS.COM

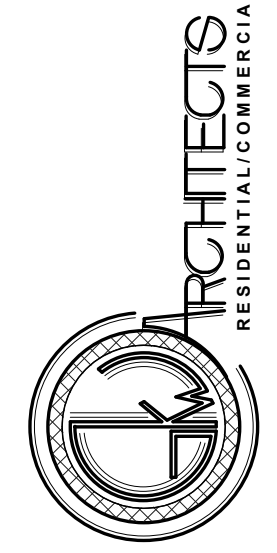

**396 Third Ave
 Mixed-Use Development**
 396 Third Ave., Redwood City, CA 94063

Rev. #	Date	Description
1	2019.10.31	Planning, Geo., PW
2	2019.10.31	File
3	2020.02.05	File

Elevations B&W

A201

SCALE As indicated

2/6/2020 9:58:35 AM

Elevations B&W



1 North Elevation Proposed
 1/8" = 1'-0"
 0' 4' 8' 16' 32'

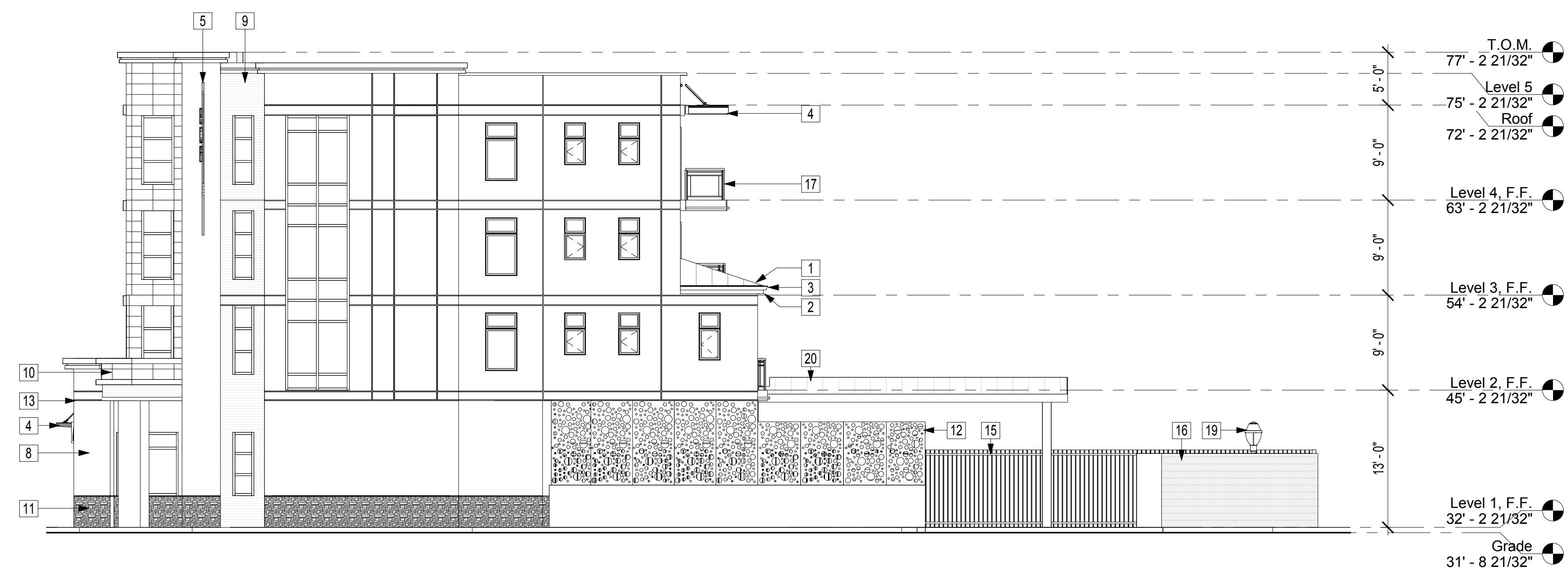

2 West Elevation Proposed
 1/8" = 1'-0"
 0' 4' 8' 16' 32'

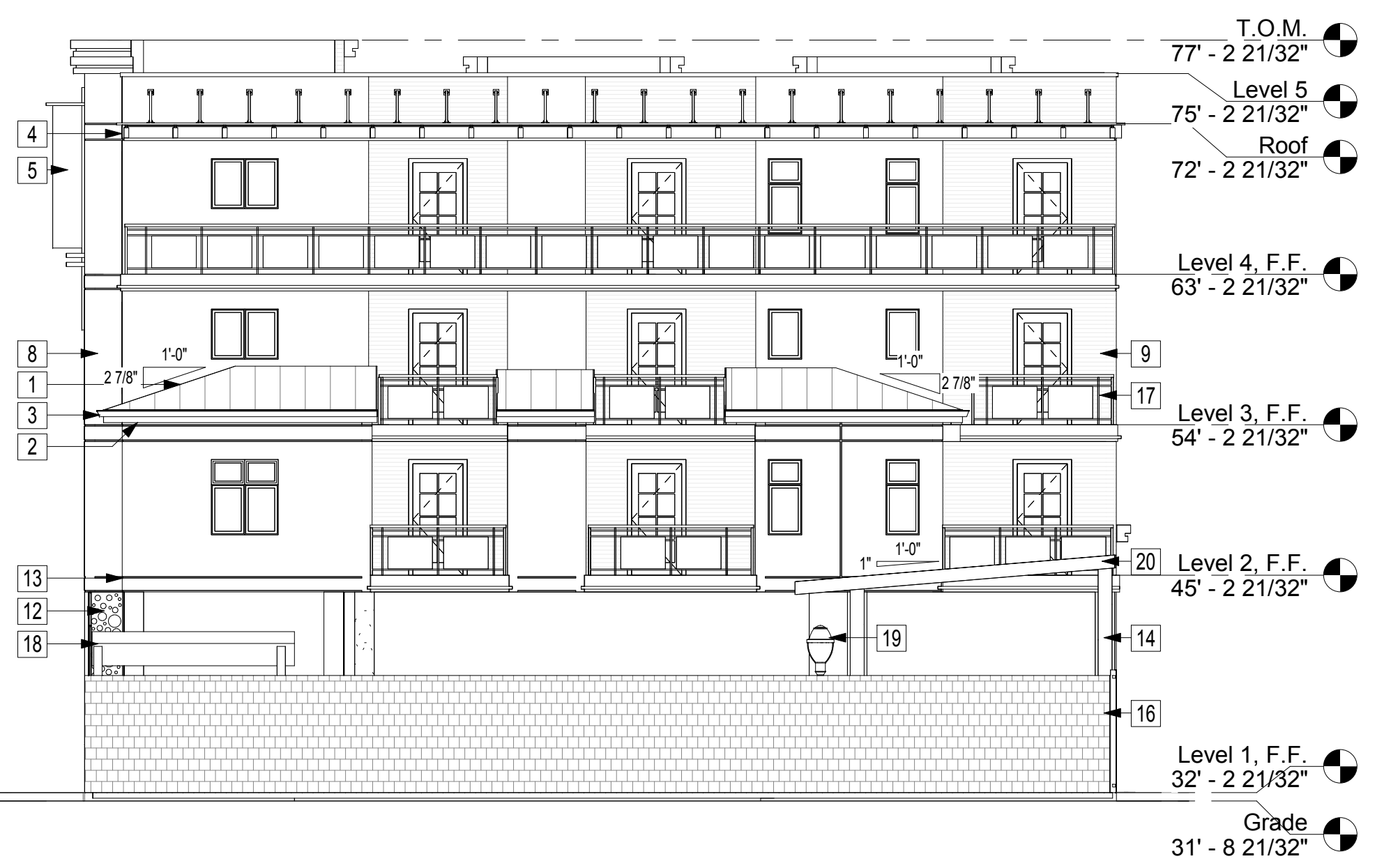

4 South Elevation Proposed
 1/8" = 1'-0"
 0' 4' 8' 16' 32'

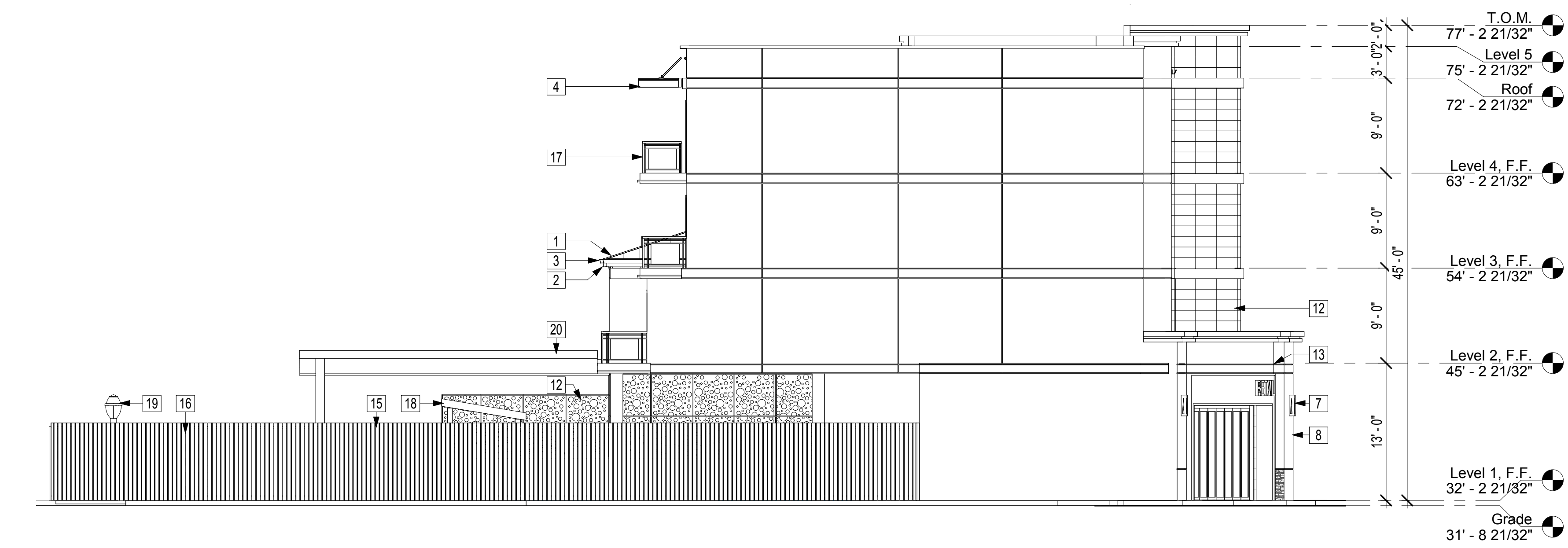

3 East Elevation Proposed
 1/8" = 1'-0"
 0' 4' 8' 16' 32'

Opening Calculation

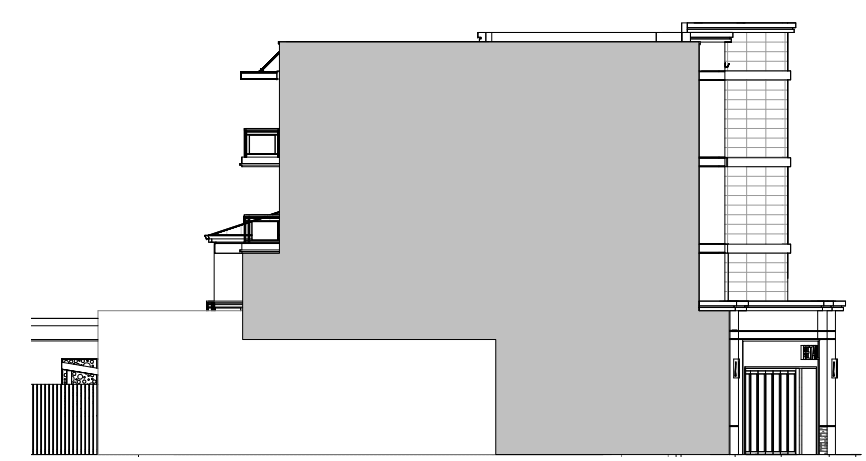

AREA 1892 SF
OPENING AREA SUMMARY PER 2016 CBC TABLE 705.8
 EAST ELEVATION, LEVELS 1-4
 FIRE SEPARATION DISTANCE = 0' < 3'
 DEGREE OF OPENING PROTECTION = UNPROTECTED, SPRINKLERED (UP, S)
 ALLOWABLE AREA = EXTERIOR WALL OPENING AREAS ARE NOT PERMITTED
 EXTERIOR WALL OPENING PROVIDED(FIT)= 0 = OKAY

5 East Elevation, Opening Calc.
 1" = 20'-0"

Exterior Elevation Keynotes

- | | | |
|----------------------------|--------------------------------|---------------------------|
| 1 STANDING SEAM METAL ROOF | 8 STUCCO | 15 WOOD FENCE, 72" HEIGHT |
| 2 FASCIA | 9 LAMBOO EXTERIOR, ACCENT | 16 CMU WALL, 72" HEIGHT |
| 3 GUTTER | 10 ALUMINUM CLADDING, ACCENT | 17 RAILING |
| 4 TRELLIS | 11 CULTURED STONE, BASE ACCENT | 18 GARBAGE ENCLOSURE |
| 5 DECORATIVE SIGNAGE | 12 PERFORATED METAL CLADDING | 19 LIGHT POST |
| 6 BUILDING SIGNAGE | 13 STUCCO REVEAL LINE | 20 3-CAR CARPORT |
| 7 EXTERIOR LIGHTING | 14 CONCRETE COLUMN, 14" X 14" | |

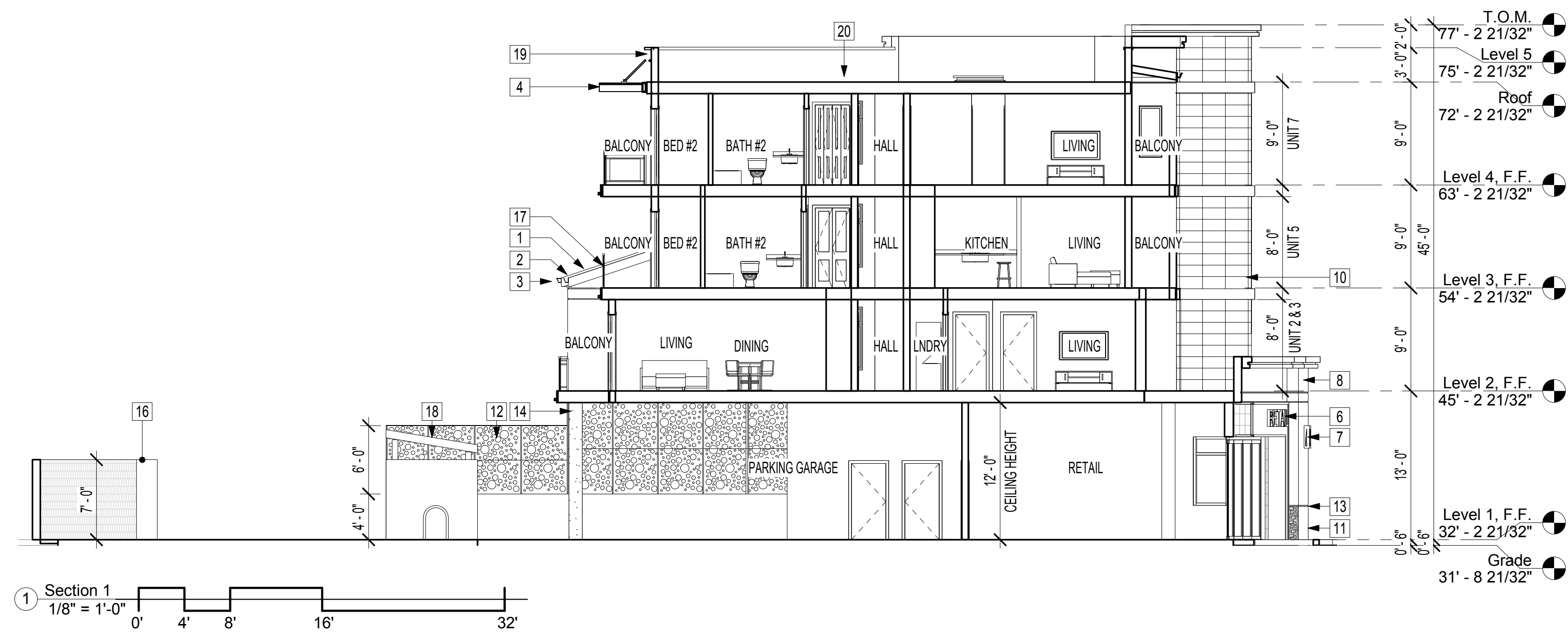

① Section 1
1/8" = 1'-0"

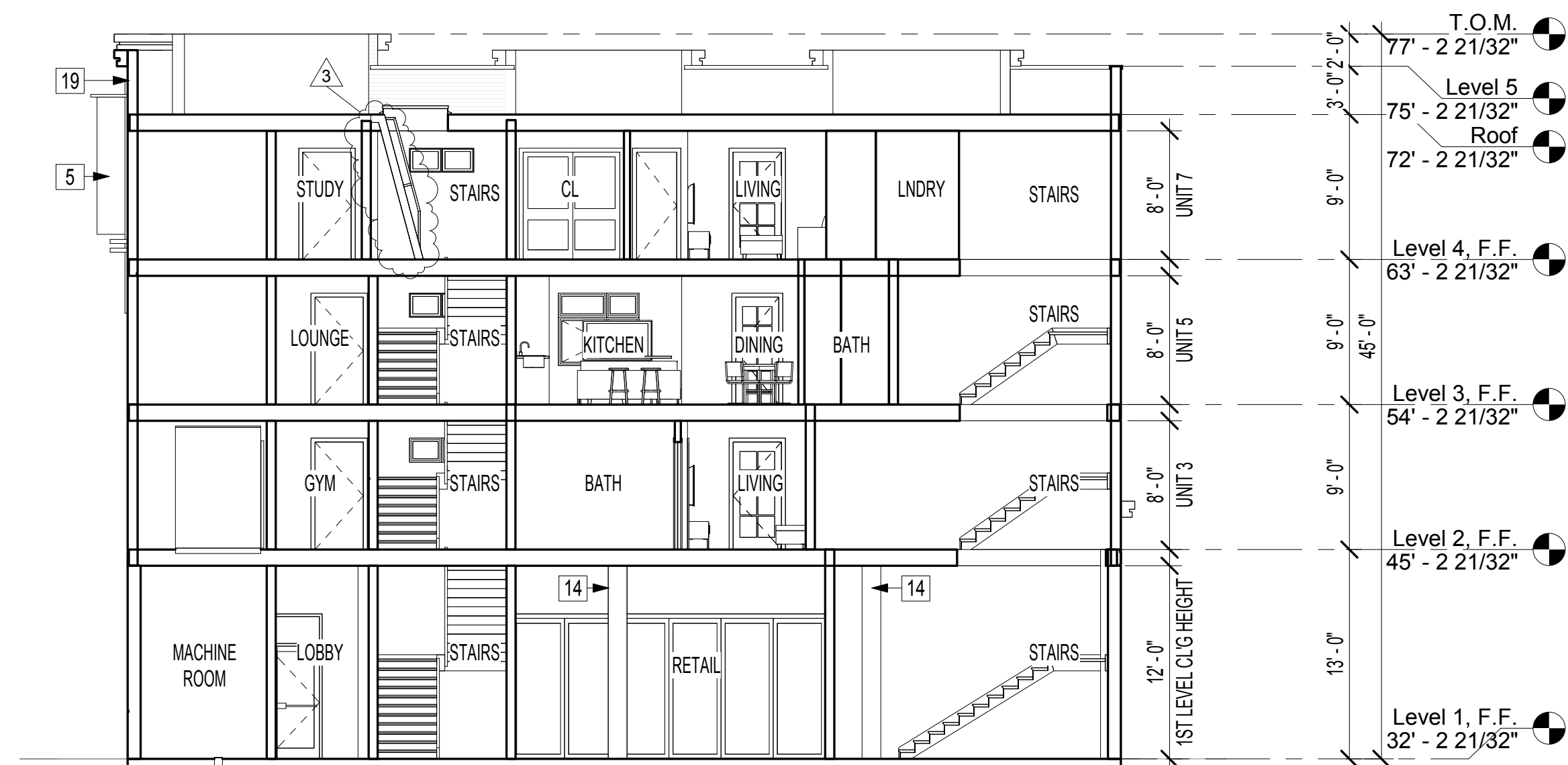

② Section 2
1/8" = 1'-0"

Section Notes

FIREBLOCKING NOTES

PROVIDE FIREBLOCKING PER CRC SECTION 302.11 AT THE FOLLOWING COMBUSTIBLE CONSTRUCTION LOCATIONS:

- IN CONCEALED SPACES OF STUD WALLS AND PARTITIONS, INCLUDING FURRED SPACES AND PARALLEL ROWS OF STUDS OR STAGGERED STUBS, AS FOLLOWS: 1.1. VERTICALLY AT THE CEILING AND FLOOR LEVELS, 1.2. HORIZONTALLY AT INTERVALS NOT EXCEEDING 10 FEET
- AT INTERCONNECTIONS BETWEEN CONCEALED VERTICAL AND HORIZONTAL SPACES SUCH AS OCCUR AT SOFFITS, DROP CEILINGS, AND COVE CEILINGS
- IN CONCEALED SPACES BETWEEN STAIR STRINGERS AT THE TOP AND BOTTOM OF THE RUN. ENCLOSED SPACES UNDER STAIRS SHALL COMPLY WITH SECTION R302.7
- AT OPENINGS AROUND VENTS, PIPES, DUCTS, CABLES, AND WIRES AT CEILING AND FLOOR LEVEL, WITH AN APPROVED MATERIAL TO RESIST THE FREE PASSAGE OF FLAME AND PRODUCTS OF COMBUSTION. THE MATERIAL FILLING THIS ANNULAR SPACE SHALL NOT BE REQUIRED TO MEET THE ASTM E136 REQUIREMENTS.

CORRIDORS - PER CBC 1020.1:
CORRIDORS SHALL BE FIRE-RESISTANCE RATED IN ACCORDANCE WITH TABLE 1020.1. EXCEPTION:

- A FIRE RESISTANCE RATING IS NOT REQUIRED FOR CORRIDORS WITHIN OPEN PARKING SPACES.
- A FIRE RESISTANCE RATING IS NOT REQUIRED FOR CORRIDORS CONTAINING WITHIN A DWELLING UNIT IN AN OCCUPANCY GROUP R.
- CORRIDORS ADJACENT TO THE EXTERIOR WALL OF THE BUILDINGS SHALL BE PERMITTED TO HAVE UNPROTECTED OPENING ON UNRATED EXTERIOR WALLS WHERE UNRATED WALLS ARE PERMITTED PER TABLE 602 AND UNPROTECTED OPENINGS ARE PERMITTED BY TABLE 705.8.

CORRIDOR FIRE RESISTANCE RATING ANALYSIS - PER TABLE 1020.1:

LEVEL 1: GROUP R-2:39 OCC. > 10 OCC. = REQUIRED 1 HOUR RATING
 LEVEL 4: GROUP R-2:13 OCC. > 10 OCC. = REQUIRED 1 HOUR RATING
 LEVEL 3: GROUP R-2:13 OCC. > 10 OCC. = REQUIRED 1 HOUR RATING
 LEVEL 2: GROUP R-2:15 OCC. > 10 OCC. = REQUIRED 1 HOUR RATING

MIXED OCCUPANCIES SEPARATION

- BUILDING EQUIPPED THROUGHOUT WITH AN AUTOMATIC SPRINKLER SYSTEM SHALL REQUIRE A 1 HOUR FIRE SEPARATION. (PER CBC TABLE 508.4)
- AUTOMATIC SPRINKLER SYSTEMS SHALL BE DESIGNED AND INSTALLED IN ACCORDANCE WITH CBC SECTION 903.3.1 THROUGH 903.3.6.
- 1-HOUR FIRE BARRIERS OR HORIZONTAL ASSEMBLIES USED FOR INCIDENTAL USE SEPARATIONS IN BUILDING OF TYPE IIB, IIB, AND VB CONSTRUCTION IS NOT REQUIRED TO BE FIRE-RESISTANCE RATED UNLESS REQUIRED BY OTHER SECTIONS OF THIS CODE. (PER SECTION 509.4.1)
- FIRE PARTITIONS SHALL HAVE A FIRE-RESISTANCE RATING OF NOT LESS THAN 1 HOUR. (PER SECTION 708.3)
- DWELLING UNIT AND SLEEPING UNIT SEPARATIONS IN BUILDINGS OF TYPE VB CONSTRUCTION SHALL HAVE FIRE-RESISTANCE RATINGS OF NOT LESS THAN 1/2 HOUR IN BUILDINGS THROUGHOUT WITH AN AUTOMATIC SPRINKLER SYSTEM IN ACCORDANCE WITH SECTION 903.3.1. (PER SECTION 708.3, EXCEPTION 2).
- WHERE THE HORIZONTAL ASSEMBLY SEPARATES MIXED OCCUPANCIES, THE ASSEMBLY SHALL HAVE A FIRE-RESISTANCE RATING OF NOT LESS THAN THAT REQUIRED BY SECTION 508.4 BASED ON THE OCCUPANCIES BEING SEPARATED.

TABLE 508.4 REQUIRED SEPARATION OF OCCUPANCIES (HOURS)
BUILDINGS EQUIPPED THROUGHOUT WITH AN AUTOMATIC SPRINKLER SYSTEM

OCCUPANCY	A	R-2	S-2	CHECK
A	NO REQUIREMENT	-	-	OKAY
R-2	1	NO REQUIREMENT	-	OKAY
S-2	1	1	NO REQUIREMENT	OKAY

CORRIDOR FIRE RESISTANCE RATING - PER CBC TABLE 1020.1

OCCUPANCY	OCCUPANT LOAD SERVED BY CORRIDOR	REQUIRED FIRE-RESISTANCE RATING	
		WITHOUT SPRINKLER SYSTEM	WITH SPRINKLER SYSTEM
A, M, S	GREATER THAN 30	1	0
R-2	GREATER THAN 10	1	1

Section Keynotes

- | | | |
|------------------------------|-------------------------------------|---|
| 1 STANDING SEAM METAL ROOF | 11 CULTURED STONE, BASE ACCENT | NOTES: CONTRACTOR AND OWNER TO VERIFY ALL DIMENSIONS AND DESIGNS AT SITE. |
| 2 FASCIA | 12 PERFORATED METAL CLADDING | |
| 3 GUTTER | 13 STUCCO REVEAL LINE | |
| 4 TRELLIS | 14 CONCRETE COLUMN, 14" X 14" | |
| 5 DECORATIVE SIGNAGE | 15 WOOD FENCE, 72" HEIGHT | |
| 6 BUILDING SIGNAGE | 16 CMU WALL, 72" HEIGHT | |
| 7 EXTERIOR LIGHTING | 17 RAILING | |
| 8 STUCCO | 18 GARBAGE ENCLOSURE | |
| 9 LAMBOO EXTERIOR, ACCENT | 19 ROOF PARAPET | |
| 10 ALUMINUM CLADDING, ACCENT | 20 STAIRWAY ROOF ACCESS, PENT HOUSE | |



WEIRAN JIA, JENNY C WONG & DANNA BAHARRAL, DESIGNER
 ARCHITECTS
 710 S MCCLINTOCK LANE, SUITE 108, CAMPBELL, CA 95008
 (408) 783-0481 | WWW.GWARCHITECTS.COM

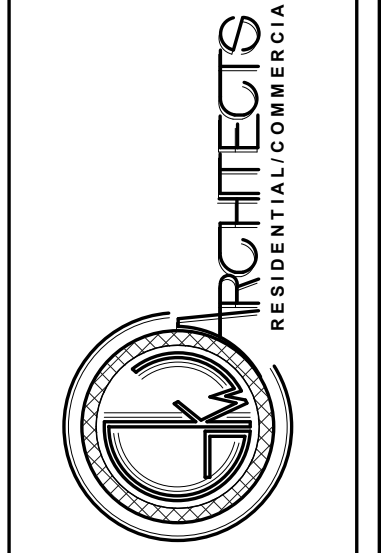

Proposed Cross Section

**396 Third Ave
Mixed-Use Development**
 396 Third Ave., Redwood City, CA 94063

Project Schedule Revision

Rev. #	Date	Description
1	2019.10.31	Planning, Geo., PW
2	2019.10.31	Fire
3	2020.02.05	Fire

Proposed Cross Section

A300

SCALE 1/8" = 1'-0"

2/6/2020 9:58:37 AM

MIXED-USE DEVELOPMENT

Material Board | 396 3rd Ave, Redwood City, CA 94063



1 LAHABRA® STUCCO - STANDARD COLORS

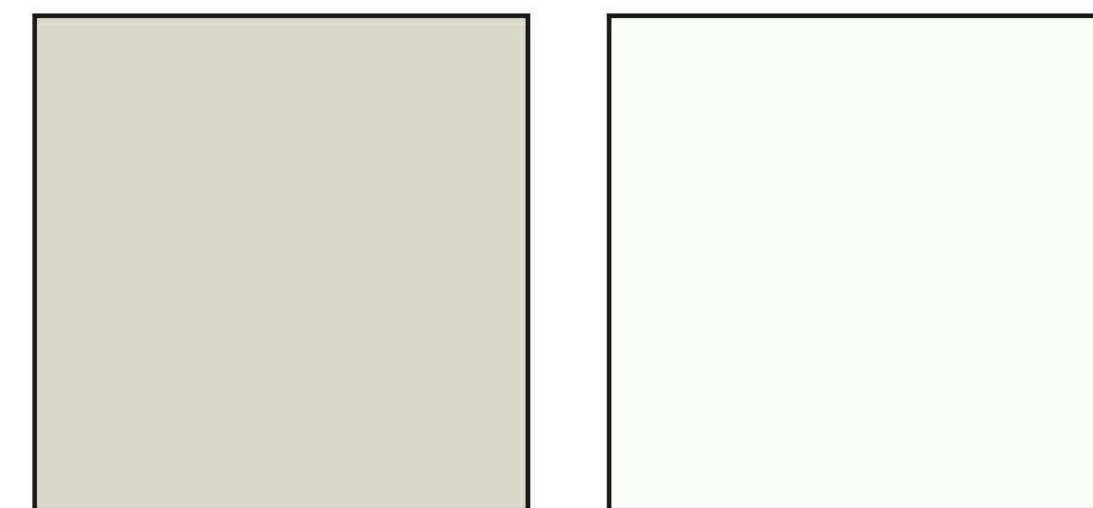

Mesa Verde
215 (48)
Base 200

Dove Grey
40 (66)
Base 200

2 LAMBOO® ELEMENTS™

Series: Exterior Cross-Ply Panel Products
Color: Vertical Fawn (Pre-Finished)
Dimension: 1/2" x 48" x 96" (3-Ply)



VERTICAL FAWN
PRE-FINISHED

3 CITADEL® ARCHITECTURAL PRODUCTS

Series: Envelope 2000®
Composition: Prefinished Smooth Aluminum Face
Panel Weight: 1.33 lb / ft²
Thickness: 1/8"

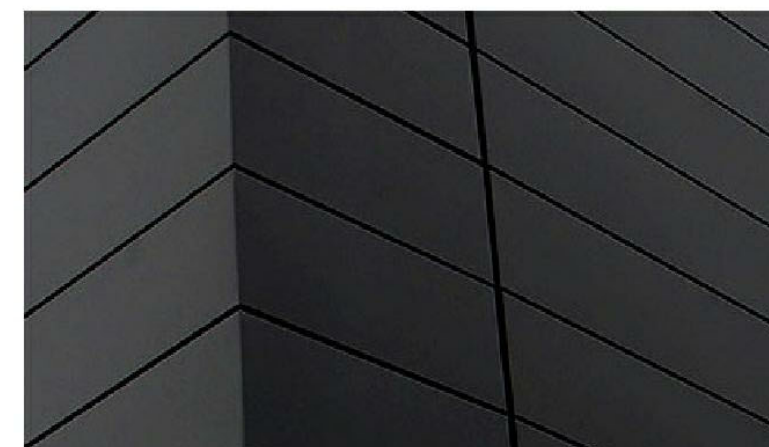

Shop-Fabricate
ACM / MCM

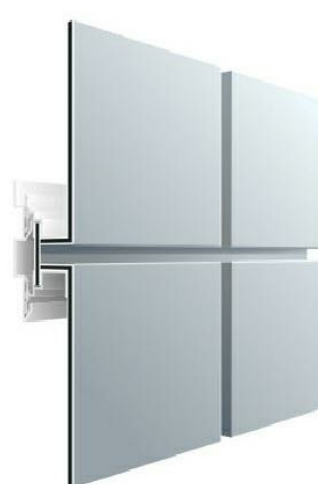

Shop-Fabricate
ACM / MCM



Series F
Satuary Bronze

4 VINYL CORP.® - CHANNEL REVEAL

Reveal: 1/2"
Width: 2 - 1/2"
Type: Perforated Flanges



Stucco Reveal

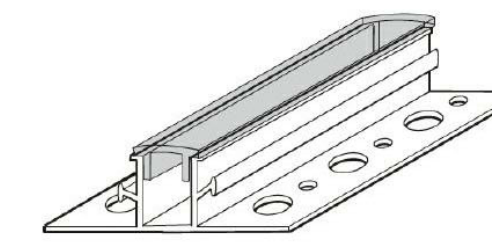

1/2" Channel Reveal

5 FORTRESS™ RAILING PRODUCTS

3" Aluminum Rails with Clear Baluster
3" Aluminum Post with Evolve External Brackets
Fortress Accents 3" Post Cap with a 3" Glow Ring

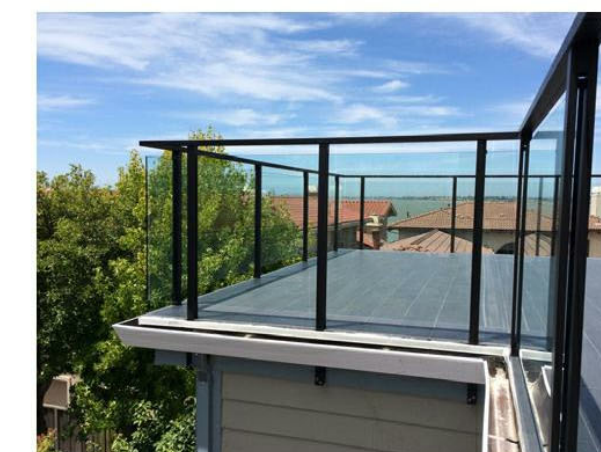

Pure View Glass Railing

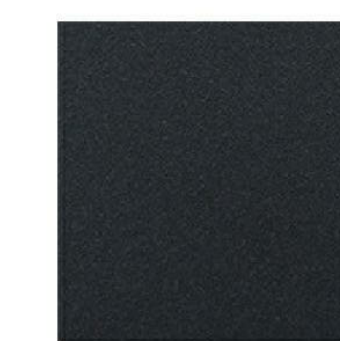

Black Sand

6 IMPACTSIGNS®

Type: Backlit Letters
Material: Fabricated Stainless Steel
Color: Dark Bronze
Font: Arial



Exterior Lighted Signs



0312
Medium Bronze



5687
White

7 MILGARD® WINDOWS

Glass: Cardinal Low-E
Frame: Vinyl - Bronze
Grids: Simulated Divided Lite (SDL)
Styles: Casement / Radius / Picture



Frame Color:
Frost



Tinted Glass
Cardinal Low-E

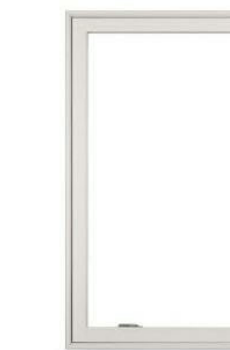

Casement



Picture

8 ANDERSEN® DOORS

Glass: Low-E Clear Glass
Frame: Aluminum
Color: Black



Fullview
Interchangeable



Hardware
Modern
Bushed Dark Nickel



Black

9 PROGRESS LIGHTING™



Outdoor Wall Sconce

Material Board

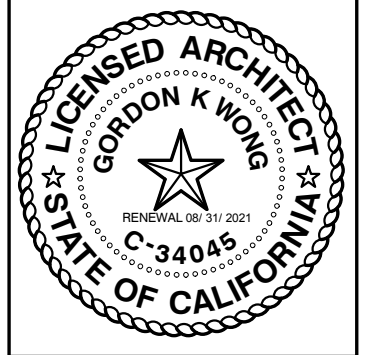

WEIRAN JIA, JENNY C WONG & DANNA BAHARRA, DESIGNER
GOW ARCHITECTS, INC.
710 BUCKINGHAM LANE SUITE 108, CAMPBELL, CA 95008
(408) 783-1481 | WWW.GOWARCHITECTS.COM

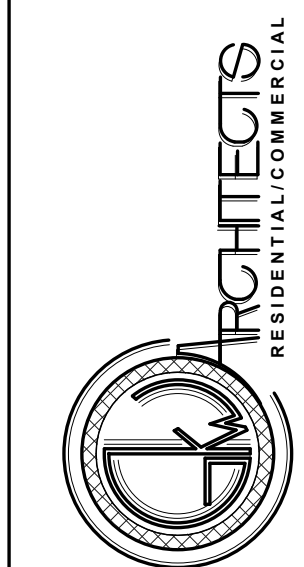

396 Third Ave
Mixed-Use Development
396 Third Ave, Redwood City, CA 94063

Rev. #	Date	Description
1	2019.10.31	Planning_Geo_PW
2	2019.10.31	File
3	2020.02.05	File

Material Board

A400

SCALE 1 1/2" = 1'-0"

2/6/2020 9:58:39 AM